

Whiz

Operational Manual

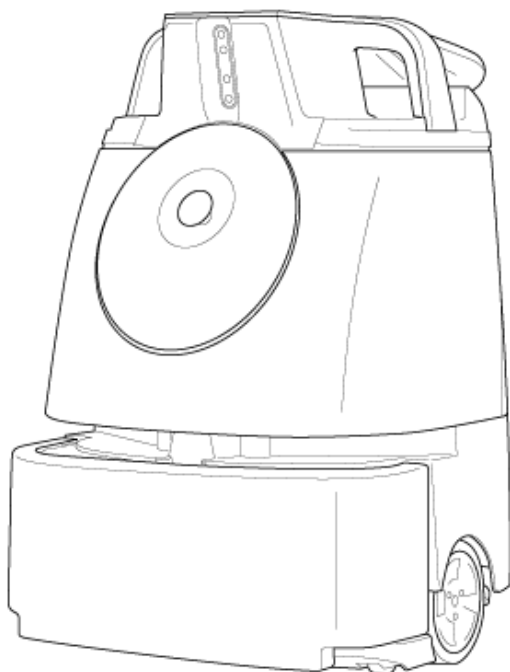

TABLE OF CONTENTS

Introduction

Introduction	1
--------------	---

Safety Warnings

Safety Warnings	2
About Safety Warnings	2
Description of Symbols	3
Description of Pictorial Indications	3
Handling the Machine, Battery Charger, Battery and Notification Pager (Common)	4
Handling the Machine	6
Handling the Battery Charger	9
Handling the Notification Pager	12
Handling the Battery	13
Handling near Electronic Medical Devices	14
Lasers and Infrared Light	14
Sensor Detection Range	14
Pictorial Symbols	14
Machine Disposal and Recycling	16

Supplied Accessories

Supplied Accessories	17
Items Delivered with/inside the Accessory Box	17
Items Delivered Separately	18

Names of Parts

Names of Parts	19
----------------	----

Machine Setup and Parts Installation

Unpacking the Machine	21
Preparing to Use the Machine	25
Check the Emergency Stop Button	25

Check the Dustbag	25
Check the HEPA Filters	27
Check the Hopper Tray	28
Installing the Brush	28
Charging the Battery and Installing it into the Machine	34
Removing the Protective Film	36
Turning the Notification Pager Power On	36
Connecting to Robot Operations Center (ROC)	37
Operation	
Operation	38
Main Power Switch	38
Turning the Power On	38
Turning the Power Off	38
Secondary Battery Power Button	39
LED Lights	42
Touch Display	44
Indications on the Touch Display	44
Vacuum Power Button	46
Max Power Mode Button	46
Steering Handle	47
Using the Steering Handle	47
Stowing the Steering Handle	48
Notification Pager	48
Autonomous Clean Start/Stop Button	49
Inspection before Operating the Machine	
Inspection Before Operating the Machine	50
Inspecting the Machine	50
Inspecting the Cleaning Area	50

Autonomous Cleaning (Robot)

Autonomous Cleaning (Robot)	51
Overview	51
Home Location Codes	52
Locations for Placing Home Location Codes	53
Scanning Home Location Codes	53
Group Function and Cleaning Routes	54
Precautions when Teaching a Cleaning Route	54
Teaching a Cleaning Route Manually	58
Planning a Cleaning Route	58
Teaching and Saving a Cleaning Route	59
Teaching a Cleaning Route Automatically	64
Carrying Out Autonomous Cleaning	70
Deleting Cleaning Routes	74

Manual Cleaning

Manual Cleaning	77
-----------------	----

Notification Pager

Notification Pager	79
Notification Pager Functions	80
Notification Pager Functions & Usage	81
Alert display and its notification timing	82
Turning the Notification Pager On/Off	83
Turning the Notification Pager On	83
Turning the Notification Pager Off	84
Pairing the Notification Pager	85
Recharging the Notification Pager	87

Machine Battery; Recharging the Machines Battery

Machine Battery; Recharging the Machine's Battery	88
About Battery and Recharging	88

Recharging the Battery	88
Battery Charger Status Indicator	92
Maintenance and Safety	
Maintenance and Safety	93
About Maintenance and Safety	93
Brush	93
HEPA Filters	99
Dustbag	100
Hopper Tray	105
Battery Charger	107
Sensors	108
Storing the Machine	111
Packaging the Machine	112
Troubleshooting	
Troubleshooting	115
Stopping/Pausing the Machine	115
Emergency Stop	116
Stopping the Machine in an Emergency	116
Releasing the Machine from Emergency Stop	117
Checking Machine Alerts	118
Machine Specifications	
Machine Specifications	119
Glossary	
Glossary	120

Introduction

Whiz is an industrial-purpose robot vacuum machine developed by SoftBank Robotics and which features onboard BrainOS.

It is able to clean in two different modes (autonomous cleaning mode/manual cleaning mode). In autonomous cleaning mode, the machine cleans automatically, controlled by the BrainOS.

- The contents described in the Operation Manual may be changed without prior notice due to specification change, etc.

Safety Warnings

About Safety Warnings

IMPORTANT SAFETY INFORMATION: Please read and understand these Safety Warnings prior to unpacking and using the machine.

Warnings presented here are intended to warn the user of potential harm to the user and other persons as well as damage to property. Always adhere to them to reduce the potential for harm.

This manual also provides safety warnings, correct handling procedures, and other regulatory information for using the machine, notification pager, battery, and battery charger. Warnings provided in this manual do not cover all possible situations that may arise.



Always adhere to warnings regarding machine installation, maintenance, and use and store this manual where it can always be referred to.

In the following emergencies, immediately press the emergency stop button and turn off the main power switch.

- The machine is in a hazardous state (example: emitting smoke, is inoperable, has fallen over, etc.)
- The machine comes close to inflicting harm on surrounding persons or things.
- The machine is operating (behaving) unpredictably or is operating in a manner that is inconsistent with this manual.





Description of Symbols

The following symbol categories explain the level of harm or damage that can occur if warnings are not observed and the machine or related equipment is used incorrectly. Please be sure you understand these symbols and their correlating meanings before reading the remainder of this manual.

 DANGER	Indicates a hazardous situation that, if not avoided, will result in death or serious injury.
 WARNING	Indicates a hazardous situation that, if not avoided, could result in death or serious injury.
 CAUTION	Indicates a hazardous situation that, if not avoided, could result in minor or moderate injury.

Description of Pictorial Indications

The following pictorial indication categories explain information to be observed. Read this guide after thoroughly understanding the information.

	Prohibited (not allowed) action.		Compulsory action based on instruction (must be performed).
	Must not be used where exposed to water, and must not be splashed with water.		Unplug the power plug from the outlet.

Handling the Machine, Battery Charger, Battery and Notification Pager (Common)

DANGER



Do not use, recharge, or leave the machine, battery charger, battery or notification pager in a place subject to high temperature (near sparks or flames, near a heater, where there is direct sunlight, in a car on a hot day, etc.) or in a warm place or where heat collects (under a radiator, hot water tank or other warm locations). Maintain adequate ventilation and make sure not to cover the machine, battery charger, battery or notification pager with any kind of fabric.

High temperatures may cause deformation, malfunction, overheating, ignition, fire, electric shock, rupture, or damage to the machine, battery charger, battery or notification pager. High temperatures may also cause the battery to leak or cause a portion of the machine case to become hot enough to cause burns.



Do not drop, break, deform, puncture, gouge, burn, or paint the machine, battery charger, battery or notification pager.

Doing so may cause fire, injury, electric shock, damage, malfunction, overheating, leakage, chemical explosion, or other damage to the machine, battery charger, battery or notification pager or surrounding individuals or property.



Do not carry out repairs, such as disassembly (removing parts, etc.), modification, soldering, or replacement of notification pager battery or secondary battery power.

- This may cause an accident such as fire, injury, electric shock, damage, malfunction, chemical explosion, or other damage to the machine, battery charger, battery or notification pager or surrounding individuals or property. May also cause leakage, overheating, rupture, ignition, or other damage to the battery pack.
- Modification of the machine may be a violation of the rules and regulations promulgated by the Federal Communications Commission, and may be subject to penalty.
- Servicing, disassembly, modification, soldering, replacement or other repair work may not be undertaken by persons other than by SoftBank Robotics or other authorized service staff.



Use only the battery charger and battery that came with the machine when recharging the machine.

Use of other battery chargers or batteries may cause fire, injury, electric shock, damage, malfunction, overheating, leakage, chemical explosion, or other damage to the battery charger.



Do not touch the battery, notification pager, or battery charger when recharging the battery or notification pager.

Doing so may cause low-temperature burns.



Do not get the machine, battery charger, battery, or notification pager wet.

- The machine, battery charger, battery and notification pager are all for INDOOR USE ONLY. They are not water resistant. Do not get them wet.
- Use in an environment with less than 80% humidity. Do not use in a humid place such as in a bathing area or where there is a sink, or where the machine and related equipment may be exposed to water. Do not use with wet hands. Failure to adhere to these warnings may cause fire, injury, electric shock, damage, malfunction, overheating, leakage chemical explosion, or other damage to the machine, battery charger, battery or notification pager.
- Leaving or recharging the machine or related equipment while it is still wet or after any liquid or quasi-liquid substance enters any part of the machine may cause fire, injury, electric shock, damage, malfunction, overheating, leakage chemical explosion, or other damage to the machine, battery charger, battery or notification pager.



Do not allow the machine to fall over or drop when moving or transporting it.

Doing so may cause fire, injury, electric shock, damage, malfunction, overheating, leakage chemical explosion, or other damage to the machine, battery charger, battery or notification pager.



Do not expose to warm air from a dryer or hot water.

Doing so may cause fire, injury, electric shock, damage, malfunction, overheating, leakage chemical explosion, or other damage to the machine, battery charger, battery or notification pager.



Do not allow liquid or quasi-liquid substance or any foreign objects to touch the charging terminals or external connection terminals of the battery charger or battery, or to otherwise enter the machine.

Doing so may result in fire, injury, electric shock, damage, malfunction, overheating, leakage, chemical explosion, or other damage to the machine, battery charger, battery or notification pager.



Immediately discontinue use if anything unusual is noticed during use, recharging, or storage such as noise, smoke, odor, etc.

Failure to do so may result in fire, injury, electric shock, damage, malfunction, overheating, leakage, chemical explosion, or other damage to the machine, battery charger, battery or notification pager.



Do not force the battery into the machine or battery charger if it cannot be connected correctly.

Doing so may cause fire, injury, electric shock, damage, malfunction, overheating, leakage, chemical explosion, or other damage to the machine, battery charger, battery or notification pager, including damage or burnout of the external connection terminals.

Handling the Machine

DANGER



Use the machine within an ambient temperature range of 0°C to 45°C, humidity of 10% to 80%. Also, store in a dry environment with no dust in an ambient temperature range of 0°C to 45°C. Failure to do so may result in fire, injury, electric shock, damage, malfunction, overheating, leakage, chemical explosion, or other damage to the machine, battery charger, battery or notification pager.



The machine is solely designed for indoor use. Do not use outside such as on a street.

Doing so may cause malfunction, failure or destruction of parts due to natural elements, or other unexpected behavior as the machine is not designed for an outdoor operating environment.



Do not use the machine in a stepped location, on an uneven floor (braille blocks), or on a sloped surface.

- The machine may fall over or drop and damage the machine or floor or cause injury or damage to surrounding people or property if travelling where there are steps.
- Travelling on an uneven floor may prevent the sensors from operating normally, which may result in injury or damage to surrounding people or property.



Do not expose the machine to dust in large amounts, sand, snow, ice, water, humidity, saltwater environments, or brine mist (example: ocean environment, shore environment, etc.).

Doing so may cause malfunctioning, failure or destruction of parts due to natural elements, electric short circuiting, or other unexpected behavior or damage as the machine is not designed for an outdoor operating environment.



Do not block the machine's vents.

Doing so may cause fire, injury, electric shock, damage, malfunction, overheating, leakage, chemical explosion, or other damage to the machine, battery charger, battery or notification pager, including deformation of the machine.



Be careful that dust does not adhere to the LIDAR sensor, camera, or other sensors.

May interfere with normal machine operation or lead to an accident. See "Inspection Before Operating the Machine".



When using autonomous cleaning mode, make sure that the operator is able to respond immediately to an alert received from a special app or the notification pager.

Not observing this may lead to an accident and damage or injury involving the user, third persons, surrounding objects, or other property or animals.



When using the machine in an autonomous mode, follow the regular floor cleaning practice and use appropriate signboards (cleaning in process signboard).

Not observing this may lead to an accident and damage or injury involving the user, third persons, surrounding objects, or other property or animals.



Use the machine with its wheels always in contact with the floor. When using the machine in manual cleaning mode, avoid abrupt operation except where unavoidable.



In areas where the machine is inoperable or unmovable due to power not turning on, move the machine to a safer location.



Do not allow feet or hands to come close to the bottom of the machine. Manage the machine so that infants, children, or pets do not touch the machine.

They may be pulled under the machine, causing injury.



Do not perform any operation not given in this manual.

Use of the machine in a manner inconsistent with this manual may lead to personal injury or significant physical damage or property damage.

WARNING



Do not use the machine with the grounding chain not in contact with the floor. If the grounding chain breaks or comes off, contact customer support.

Failure to do so may cause electric shock or injury to the operator or damage to the machine.



If the secondary battery is off/low, do not remove the battery with the main power switch on the machine on.

Doing so may cause fire, injury, electric shock, damage, malfunction, overheating, leakage, chemical explosion, or other damage to the machine, battery or notification pager.



Recharge the battery for the machine using only the battery charger that came with the machine. Recharge the notification pager using only the charging stand that came with the machine.

Failure to do so may cause fire, injury, electric shock, damage, malfunction, overheating, leakage, chemical explosion, or other damage to the machine, battery charger, battery or notification pager.



Use the machine after checking for obstacles in the cleaning route.

Failure to do so may result in damage or injury to property, individuals or the machine. For the range detectable by the machine's sensors, see "Sensor Detection Range".



Do not cover the machine's sensors.

Failure to do so may result in malfunction of the machine or damage or injury to property, individuals or the machine.



Do not place anything decorative that may hinder the machine's operation or the emergency stop button.

May cause poor operation, malfunction or damage or injury to property, individuals or the machine.



When replacing the dustbag, brush, etc., turn off the main power switch beforehand and remove the battery from the machine in order to reduce risk of shock.



Do not clean the machine with a high-pressure cleaner.

Doing so may damage the machine's interior and cause unexpected behavior.



The machine is designed to clean indoor carpets and dry floors. Do not use it for any other purpose.



Do not use the machine to collect hazardous or explosive waste.

It is not certified for such collection and doing so may cause damage or injury to property, individuals or the machine.



Check that the following are not in the cleaning area.

If vacuumed, they may cause malfunction of the machine or damage or injury to property, individuals or the machine.

- Waste containing liquid or moisture
- Large amounts of sand, dust; string
- Sharp objects (glass, blades, metal fragments, etc.)
- Objects that air cannot pass through easily (food wrap, plastic; wrapping film, etc.)



When carrying out maintenance with the dustbag, brush, hopper tray, etc., please be sure to turn off the machine prior to performing such maintenance and be careful not to get your fingers caught while working.

Failure to follow these instructions may lead to injury.



The dustbag, brush, battery, HEPA filters, and notification pager are designed especially for the machine. Do not use other products.

Using other products may cause the machine to malfunction or cause damage to the machine.



When installing or removing the battery, be careful not to get your fingers, other appendages or clothing caught while working.

Not doing so may cause injury.



When lifting the machine from the floor, always use two persons as a safety precaution.

Not doing so may cause injury.



The machine cannot vacuum liquid.

Operating the machine on a wet (moist) floor may cause malfunction. Only use the machine on a dry floor.

CAUTION



If the machine has fallen over, press the emergency stop button and then turn off the main power switch on the machine.

Failure to do so may result in malfunction of the machine or damage or injury to property, individuals or the machine.



Avoid coming within 46 cm (18 inches) of the machine while it is in operation (except in manual operation mode).

When cleaning in autonomous cleaning mode, the machine sometimes suddenly turns, stops, or advances; coming close to the machine may cause injury. Abrupt motion near the machine may cause the machine to malfunction.



Do not insert any objects in the machine.

Doing so may cause fire, injury, electric shock, damage, malfunction, overheating, leakage, chemical explosion, or other damage to the machine, battery charger, battery or notification pager.



If the machine is not operating normally (unusual sound, odor, smoke, etc.), immediately press the emergency stop button, to stop machine operation, turn off the main power switch, and contact customer support.

Failure to do so may result in malfunction of the machine or damage or injury to property, individuals or the machine.

Handling the Battery Charger

DANGER



Do not use the battery charger at or near a place with dust, salt, corrosive gas, or flammable gas.

Using the battery charger at or near a place with dust, salt, corrosive gas or flammable gas could cause fire, injury, electric shock, damage, malfunction, chemical explosion, or other damage to the machine, battery charger, battery or notification pager or surrounding individuals or property.



Do not insert metal pins, or other foreign materials in the air vents in the battery charger.

Doing so may cause fire, injury, electric shock, damage, malfunction, overheating, leakage, chemical explosion, or other damage to the machine, battery charger, battery or notification pager.



Use the battery charger in an environment with an ambient temperature of 0°C to 45°C, and humidity of 20% to 85%. When not using the battery charger, store in an environment with an ambient temperature of -10°C to 60°C, and humidity of 20% to 85%.

Failure to do so may result in fire, injury, electric shock, damage, malfunction, overheating, leakage, chemical explosion, or other damage to the machine, battery charger, battery or notification pager.

 **WARNING**



Only use power cables with labels for your country (country name) of residence. Do not use other power cables.

Doing so may cause fire, injury, electric shock, damage, malfunction, overheating, leakage, chemical explosion, or other damage to the machine, battery charger, battery or notification pager.



Do not connect to any battery other than the supplied battery.

Doing so may cause fire, injury, electric shock, damage, malfunction, overheating, leakage, chemical explosion, or other damage to the machine, battery charger, battery or notification pager.



The battery charger sometimes becomes hot. Be careful during and immediately after charging.

Failure to do so may result in burns or other injuries.



Make sure not to cover the battery charger with fabric, etc. Maintain conditions that allow adequate heat dissipation, and do not use or leave near a source of heat, or where exposed to water or direct sunlight.

Failure to do so may cause fire, injury, electric shock, damage, malfunction, overheating, leakage, chemical explosion, or other damage to the machine, battery charger, battery or notification pager.



Check that the supplied voltage is appropriate for the battery charger.

Do not use any power source or voltage other than that specified (AC 100 V to 240 V, 50 Hz to 60 Hz).

Failure to use the proper power source or voltage may cause fire, injury, electric shock, damage, malfunction, overheating, leakage, chemical explosion, or other damage to the machine, battery charger, battery or notification pager.



Make sure that dirt or other foreign matter do not adhere to the battery charger.

Do not use in a dusty place. If the plug is dusty, unplug it from the outlet and wipe with a dry cloth.

Failure to do so may cause fire, injury, electric shock, damage, malfunction, overheating, leakage, chemical explosion, or other damage to the machine, battery charger, battery or notification pager.



Do not use the battery charger or power cable if damaged.

Failure to do so may cause fire, injury, electric shock, damage, malfunction, overheating, leakage, chemical explosion, or other damage to the machine, battery charger, battery or notification pager.



The battery charger is designed specifically for the machine. Use only the supplied designated power cable. Do not use the power cable with any another product.

Failure to use the supplied designated power cable may cause fire, injury, electric shock, damage, malfunction, overheating, leakage, chemical explosion, or other damage to the machine, battery charger, battery or notification pager.



The battery charger is specifically for being placed sideways. Do not use it placed standing or upside down.

Doing so may cause fire, injury, electric shock, damage, malfunction, overheating, leakage, chemical explosion, or other damage to the machine, battery charger, battery or notification pager.



Always unplug the battery charger from the outlet if not using it for a long time or when carrying out maintenance on it.

Failure to do so may cause fire, injury, electric shock, damage, malfunction, overheating, leakage, chemical explosion, or other damage to the machine, battery charger, battery or notification pager.



If the battery charger is not operating normally, takes a longer time to recharge than normal, or if it produces sparks, smoke, odor, etc., immediately unplug it from the outlet, and contact customer support.

Failure to do so may cause fire, injury, electric shock, damage, malfunction, overheating, leakage, chemical explosion, or other damage to the machine, battery charger, battery or notification pager.



If thunder is audible, unplug the battery charger from the outlet.

Failure to do so may damage the battery charger.



Do not step on the power cable or otherwise subject it to excessive force when it is connected to the battery charger.

May break the terminals on the power cable and cause malfunction or fire.



Use the battery charger distanced at least 10 cm (4 inches) from a wall so as not to block its air vents.

Blocked air vents will cause the temperature in the battery charger to rise, and may cause malfunction or fire.

CAUTION



Do not touch the surface of the battery charger for a long time.

Prolonged skin contact may cause low-temperature burns.



Make sure the battery charger is where the power plug can connect easily to an outlet. Also position the battery charger so that its charge indicators can be checked visually.



Do not drop, step on, or place objects on the battery charger, regardless of if it is connected or not. Do not use it where it may be stepped on.

The cable may break, resulting in fire, injury, electric shock, damage, malfunction, overheating, leakage, chemical explosion, or other damage to the machine, battery charger, battery or notification pager.



Always hold the plug body and not the cord when unplugging the power plug.

Handling the Notification Pager

DANGER



Do not drop or throw.

Subjecting it to strong impact may cause the battery pack in the notification pager to leak, overheat, rupture, or ignite, and otherwise result in injury, electric shock, damage, malfunction, overheating, leakage, chemical explosion, or other damage to the machine, battery charger, battery or notification pager.

WARNING



Store out of the reach of infants and pets.

Failure to do so may present a choking hazard or other risk of physical injury or death of infants or pets.



If prolonged contact with the notification pager causes skin irritation (itchiness, rash, eczema, etc.), immediately discontinue use and consult a doctor.

Handling the Battery

DANGER



Use the machine within an ambient temperature range of 0°C to 45°C. Also store in a dry environment with no dust in an ambient temperature range of 0°C to 45°C.

Failure to do so may cause fire, injury, electric shock, damage, malfunction, overheating, leakage, chemical explosion, or other damage to the machine, battery charger, battery or notification pager.



Do not place objects on top of the battery.

Doing so may cause fire, injury, electric shock, damage, malfunction, overheating, leakage, chemical explosion, or other damage to the machine, battery charger, battery or notification pager.



Do not smoke in the vicinity of the battery or place objects near it that may be the cause of flames or sparks.

Doing so may cause fire, injury, electric shock, damage, malfunction, overheating, leakage, chemical explosion, or other damage to the machine, battery charger, battery or notification pager.



Do not connect the battery terminals with metal, etc.

May cause leakage, overheating, ignition, or rupture and otherwise result in injury, electric shock, damage, malfunction, overheating, leakage, chemical explosion, or other damage to the machine, battery charger, battery or notification pager.



Do not throw into a fire or heat.

May cause leakage or explosion and otherwise result in injury, electric shock, damage, malfunction, overheating, leakage, chemical explosion, or other damage to the machine, battery charger, battery or notification pager.



If fluid leaks, do not touch with bare hands.

Doing so may cause burns or irritation. If fluid enters your eyes, wash well with clean water, and immediately consult a doctor. If fluid gets on your skin or clothes, wash well with water.



Use the battery only in the machine.

Not doing so may cause leakage, overheating, ignition, or rupture, and otherwise result in injury, electric shock, damage, malfunction, overheating, leakage, chemical explosion, or other damage to the machine, battery charger, battery or notification pager.



Do not subject to impact, such as by placing objects on it or letting it fall.

May cause overheating, ignition, or rupture, and otherwise result in injury, electric shock, damage, malfunction, overheating, leakage, chemical explosion, or other damage to the machine, battery charger, battery or notification pager.

Handling near Electronic Medical Devices



If wearing an implanted cardiac pacemaker or implanted defibrillator, consult with the manufacturer of such medical device to confirm a safe operational distance from the machine.

Electric signals may affect the operation of the pacemaker or defibrillator.



Do not use in a healthcare environment or near electronic medical devices.

* The machine does not comply with UL or IEC 60601 standards (or equivalent standards).

Lasers and Infrared Light

- The machine confirms the safety of its surrounding area by laser.
- The machine is outfitted with one Class 1 laser.
- Class 1 laser:
If within a normal range of operation, no hazard exists by looking directly at the laser beam for a long period, or by using an optical instrument for observation such as a magnifying glass or binoculars to look directly at the laser beam (compliant with JIS C6802). For information on lasers, see "Sensor Detection Range".

For details, please see "Product Certifications for Whiz/ Product Certifications for Whiz Notification Pager". You can check latest data on "Whiz Connect".

Sensor Detection Range

- The machine confirms the safety of its surrounding area with several sensors. The machine detects obstacles in a range of about 200° in front of it; do not go near the machine within the range that is not detectable by the sensors (behind it, etc.). It may not be able to detect the user as an obstacle.
- Low obstacles less than 10 cm (4 inches) in height from the floor cannot be avoided with sensor detection; remove them from the cleaning route beforehand.

Pictorial Symbols

Refer to the labels on each piece of equipment (the machine, battery charger, battery).

	Do not short-circuit.		Do not disassemble.
	Do not immerse in water or other liquid.		

■ FCC Compliance Statement

The Whiz Vacuum and the Notification Pager comply with part 15 of the FCC rules.

Note with respect to the Whiz Vacuum:

This equipment has been tested and found to comply with the limits for a Class A digital device, pursuant to part 15 of the FCC Rules. These limits are designed to provide reasonable protection against harmful interference when the equipment is operated in a commercial environment. This equipment generates, uses, and can radiate radio frequency energy and, if not installed and used in accordance with the instruction manual, may cause harmful interference to radio communications. Operation of this equipment in a residential area is likely to cause harmful interference in which case the user will be required to correct the interference at his own expense.

This equipment (**FCC ID: 2AT19-A00000101A01**) complies with FCC radiation exposure limits set forth for an uncontrolled environment. End users must follow the specific operating instructions for satisfying RF exposure compliance requirements. This transmitter must not be co-located or operating in conjunction with any other antenna or transmitter.

Note with respect to the Notification Pager:

This equipment has been tested and found to comply with the limits for a Class B digital device, pursuant to part 15 of the FCC Rules. These limits are designed to provide reasonable protection against harmful interference in a residential installation. This equipment generates, uses and can radiate radio frequency energy and, if not installed and used in accordance with the instructions, may cause harmful interference to radio communications. However, there is no guarantee that interference will not occur in a particular installation. If this equipment does cause harmful interference to radio or television reception, which can be determined by turning the equipment off and on, the user is encouraged to try to correct the interference by one or more of the following measures:

- Reorient or relocate the receiving antenna.
- Increase the separation between the equipment and receiver.
- Connect the equipment into an outlet on a circuit different from that to which the receiver is connected.
- Consult the dealer or an experienced radio/TV technician for help.

This pager device (**FCC ID: 2AT19-P00000401A01**) is designed to meet the requirements for exposure to radio waves established by the Federal Communications Commission (USA). These requirements set an SAR limit for an occupational/controlled environment of 0.4 W/kg, as averaged over the whole body, and a peak spatial average SAR of 8 W/kg, averaged over any 1 gram of tissue. The highest SAR value reported under this standard during product certification for use when properly worn on the body is 0.06 W/kg. This device was tested for typical body-worn operations with a separation of 10mm from the body. To maintain compliance with FCC radio frequency exposure requirements, use accessories that maintain a 10mm separation distance between the user's body and the back of the pager. The use of belt clips, holsters, and similar accessories that contain metallic components in their assembly should be avoided, as use of such accessories might not comply with FCC exposure requirements.

CHANGES OR MODIFICATIONS TO THE WHIZ VACUUM AND ANY COMPONENTS THEREOF (INCLUDING THE NOTIFICATION PAGER) NOT EXPRESSLY APPROVED BY SOFTBANK ROBOTICS MAY VOID THE USER'S ABILITY TO OPERATE THE EQUIPMENT.

■ IC Compliance

This device complies with Innovation, Science and Economic Development Canada S licence-exempt RSSs Operation is subject to the following conditions:

1. This device may not cause harmful interference.
2. This device must accept any interference received, including interference that may cause undesired operation.

- Body-worn operation

The device complies with RSS 102, RF specifications when used near your ear or at a distance of 20 cm from your body (20 cm RF exposure safety distance). Ensure that the device accessories, such as a device case and device holster, are not composed of metal components.

- Conformité à la réglementation canadienne

Le présent appareil est conforme aux CNR Innovation, Sciences et Développement économique Canada applicables aux appareils radio exempts de licence. L'exploitation est autorisée aux deux conditions suivantes:

1. l'appareil ne doit pas produire de brouillage;
2. l'appareil doit accepter tout brouillage radioélectrique subi, même si le brouillage est susceptible d'en compromettre le fonctionnement.

- Opération du corps porté L'appareil est conforme à la norme RSS 102, RF, lorsqu'il est utilisé près de votre oreille ou à une distance de 20 cm de votre corps (distance de sécurité d'exposition RF de 20 cm). Assurez-vous que les accessoires de l'appareil, tels que son boîtier et son étui, ne sont pas composés de composants métalliques.

CAN ICES-3 (B)/NMB-3(B)

IC: 25110-P000101A01

Machine Disposal and Recycling





The machine you have purchased is designed and manufactured with recyclable, high-quality materials and components. When disposing of the machine, check that it is being disposed of properly as industrial waste differentiated from general and business waste according to regional and municipal regulations by request to an industrial waste disposal operator.

- * If the machine is being leased, it cannot be disposed of by yourself. Contact customer support. When disposing of the machine, remove the battery from the machine, and dispose of properly according to regulations for waste disposal in the region you are residing in.

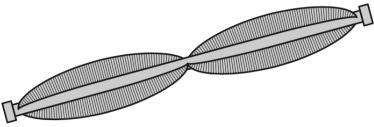

Supplied Accessories

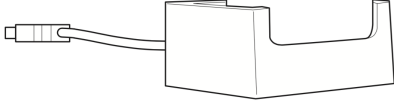
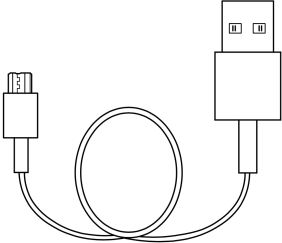
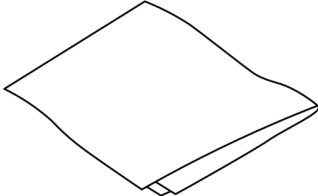
■ Items Delivered with/inside the Accessory Box

- All accessories besides the brush are stored in the accessory box inside the battery compartment (⇒see "Names of Parts").

Brush × 1	Notification pager × 1	Notification pager charger × 1
		
Micro USB cable × 1	Micro-fiber cloth × 1	Pin × 1
		

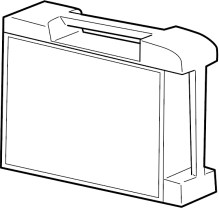
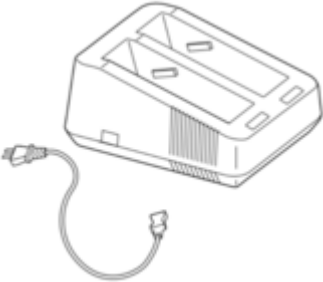
■ Items Delivered Separately

Battery×1	Battery charger (incl. 3 AC cords with country label)×1	Home Location Codes×10
		

- Depending on your contract details, Home Location Codes may be bundled with the machine.
- Dustbag, hopper tray, and HEPA filters are pre-installed in the machine at delivery.
- The brush, dustbag, HEPA filter, battery charger, battery, and Home Location Codes are consumables.

Names of Parts

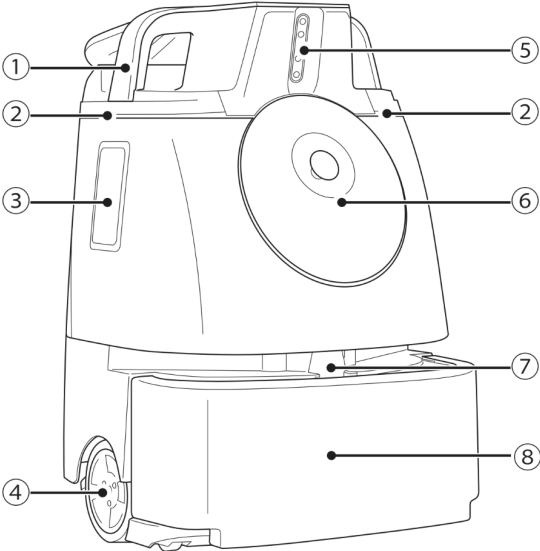
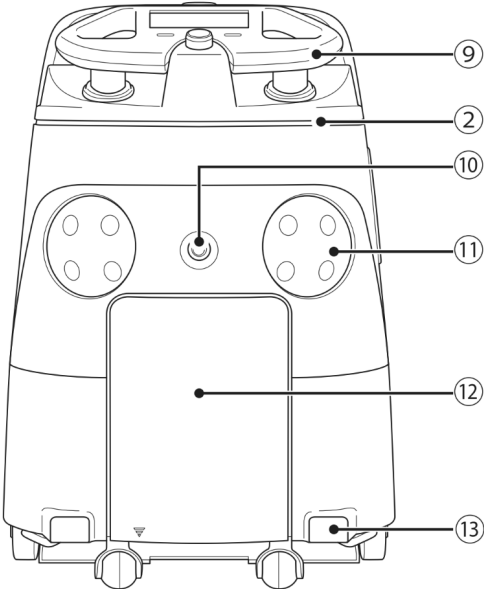
Machine Front/Side, Back	No.	Item
	1	Lift handles
	2	LED light
	3	Pager compartment
	4	Wheel
	5	2D/3D camera (sensor)
	6	Dustbin
	7	LIDAR sensor
	8	Bumper
	9	Steering handle
	10	Main power switch
	11	Filter cover
	12	Battery compartment
	13	Rubber pad

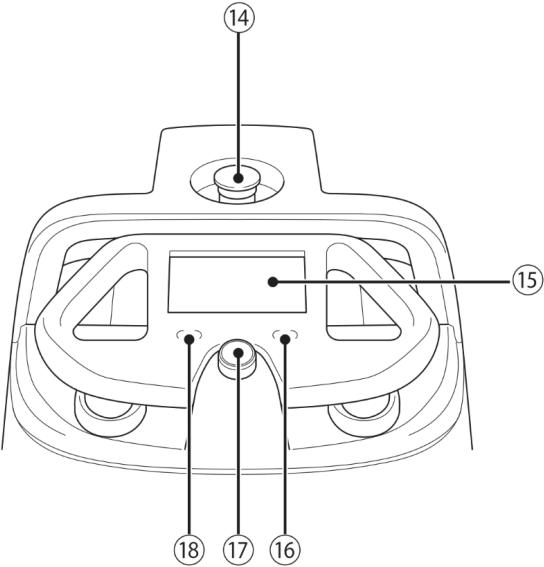
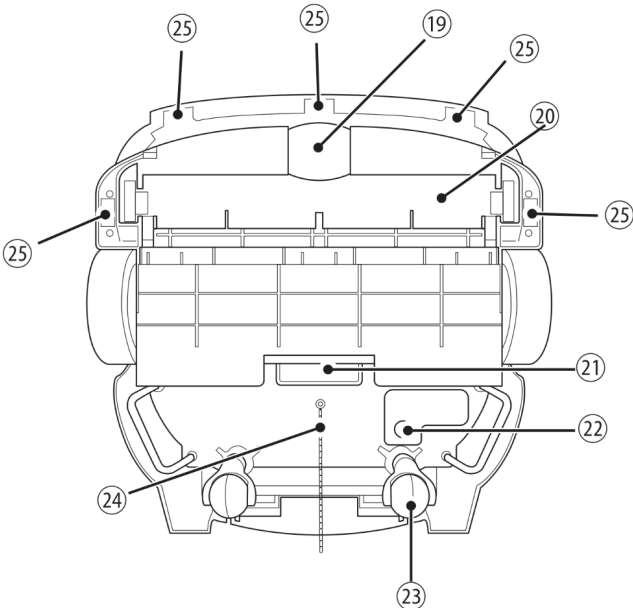
Machine Top, Bottom	No.	Item
	14	Emergency stop button
	15	Touch display
	16	Max power mode button
	17	Autonomous clean start/stop button
	18	Vacuum power button
	19	Front wheel
	20	Brush compartment
	21	Hopper tray
	22	Secondary battery power button
	23	Rear caster
	24	Grounding chain
	25	Cliff sensor

Machine Setup and Parts Installation

Unpacking the Machine

For your safety, work with more than two people when unpacking the machine.

- Check that the packaging is not damaged; if damaged, immediately contact customer support.
- Do not discard the packaging box or packing material, and store it safely.
You will need the box if storing the machine for a long period of time.(⇒see “Storing the Machine”).

1 Pinch the lock on the locking tab that is attached to the outer box.

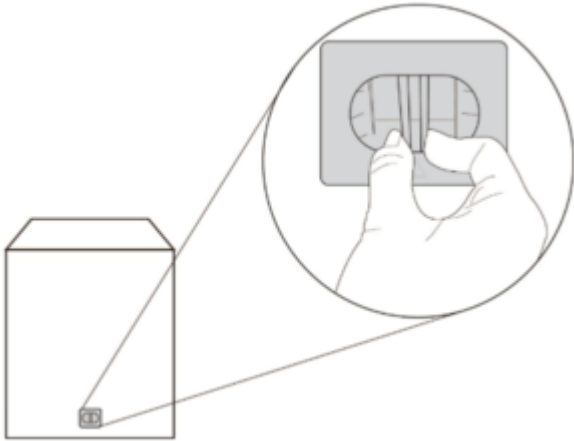

2 Lift the lock (①) and remove the locking tab (②).

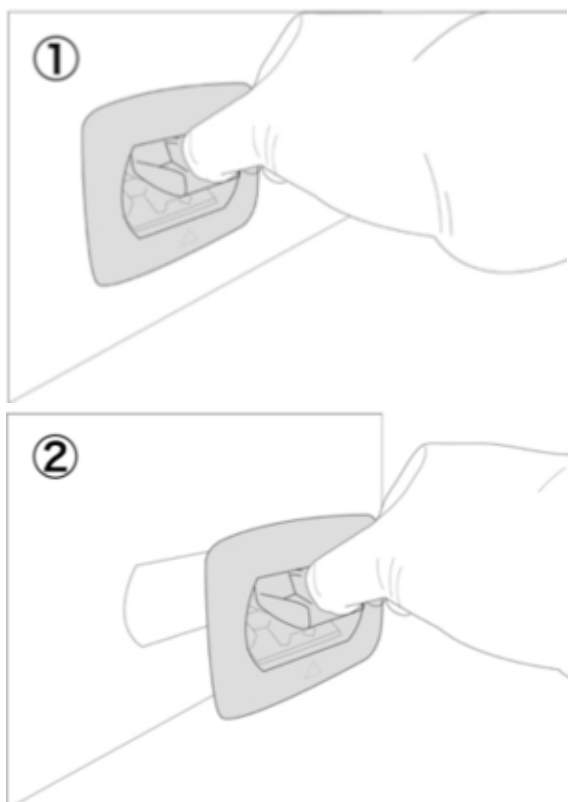

- There are 4 locking tabs located on the outer box.

3 Remove the outer box.

- Also remove the brush that is attached inside the outer box

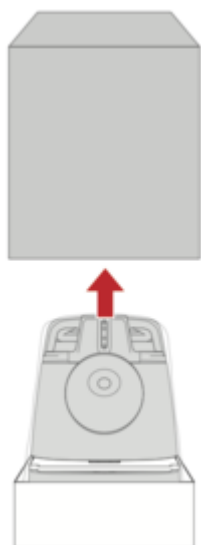

4 Remove the cushioning material.

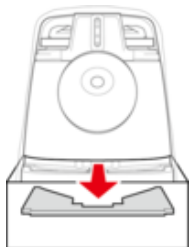

5 Take the machine out of the inner box.

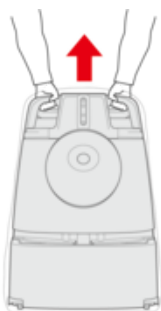

6 Remove the plastic bag.

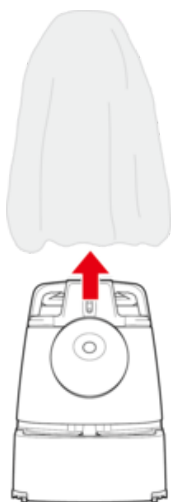

7 Remove the cushioning material (between the bumper and the machine).

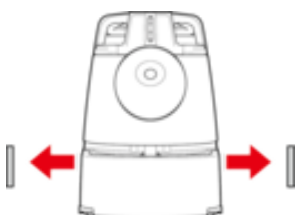

8 Either hold the liftgrip (①) or use the steering handle (②) to bring the machine to the cleaning location.

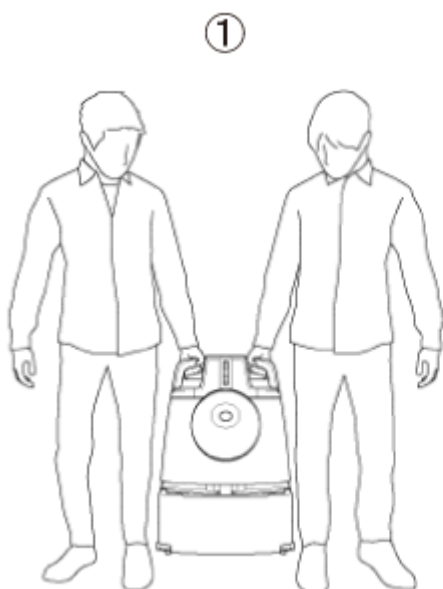

Preparing to Use the Machine

Check the Emergency Stop Button

Check that the Emergency Stop Button is not pressed. If pressed, turn it to the right to release.

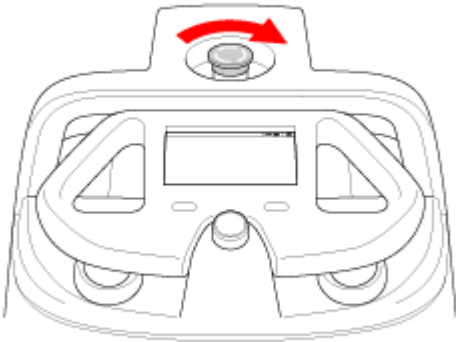

Check the Dustbag

Make sure the dustbag is properly installed to the machine. If it has not been properly installed or if the dustbin cover does not close, reinstall the dustbag by following the dustbag installation procedure (⇒see “Dustbag”).

1 Hold the dustbin access handle and pull it down

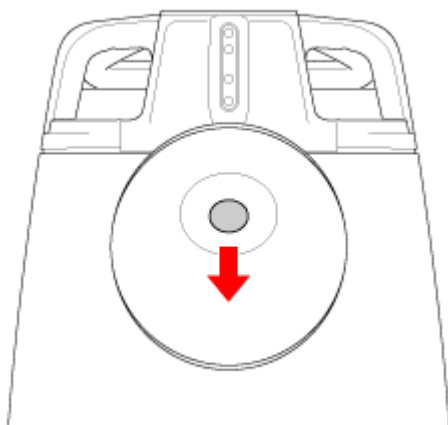

2 Remove the dustbin cover

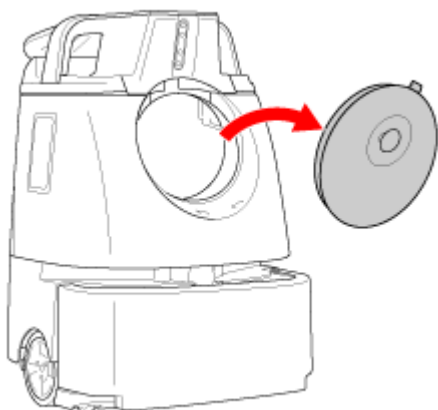

3 Check that the dustbin pin is afloat

- If the dustbag is correctly set, the pin will float.

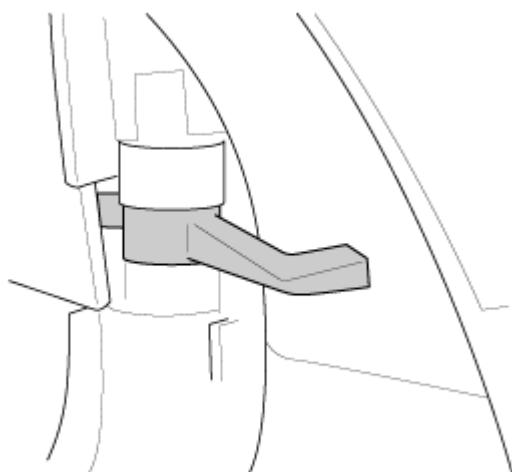

4 Insert the catches at the bottom of the cover in the bottom of the dustbin ① and close the cover while pushing down on the dustbin access handle ②

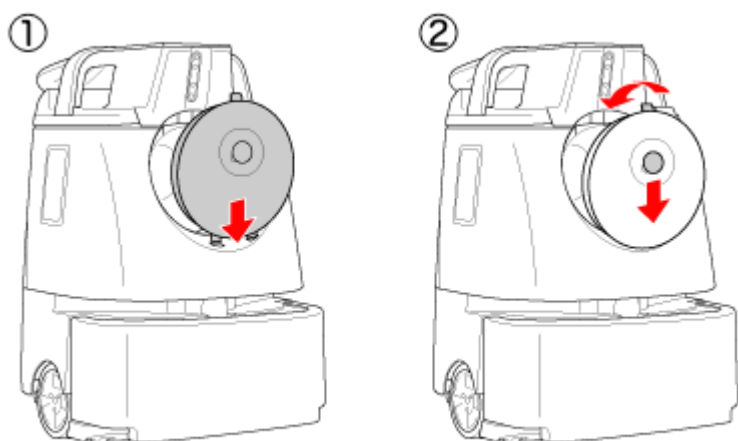

Check the HEPA Filters

Make sure the HEPA filter is properly installed to the machine. If they have not been properly installed, reinstall the filters by following the HEPA filter installment procedure (⇒see “HEPA Filters”).

- 1 Remove the cover by turning it to the left.

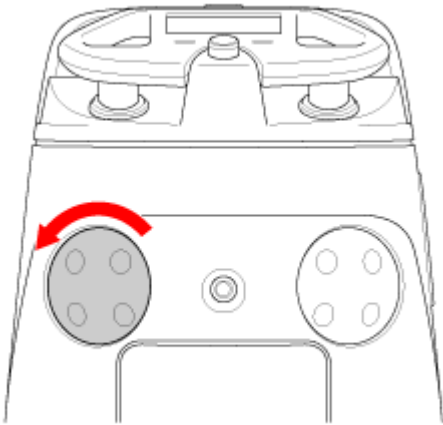

- 2 Check that the HEPA filter is properly installed

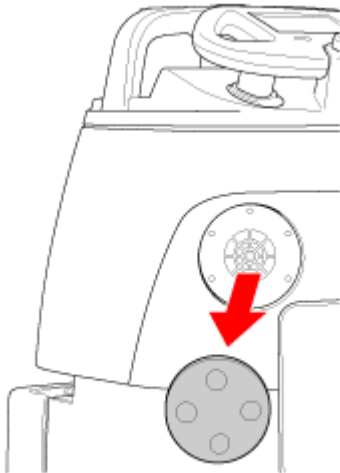

- 3 Attach the cover back on to the machine and turn it to the right until it clicks to close.

- 4 Check the other HEPA Filter with the same procedure

Check the Hopper Tray

Check that the Hopper Tray is properly installed. If it is not installed properly, reinstall the Hopper Tray (⇒See 'Hopper Tray').

- 1 From the back of the machine, check if the Hopper tray is installed correctly

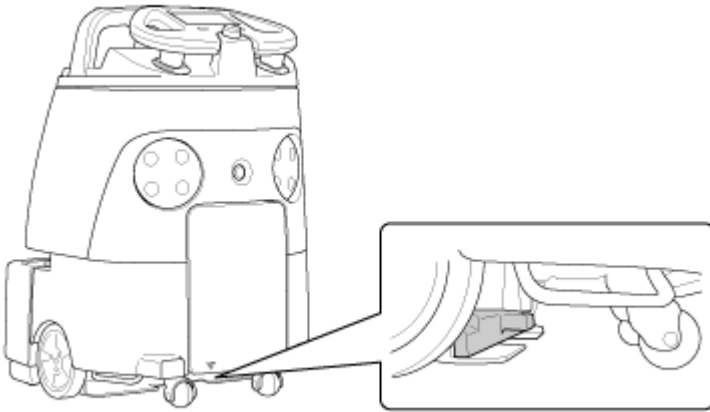

Installing the Brush

- 1 Stow the steering handle (⇒see 'Steering handle')

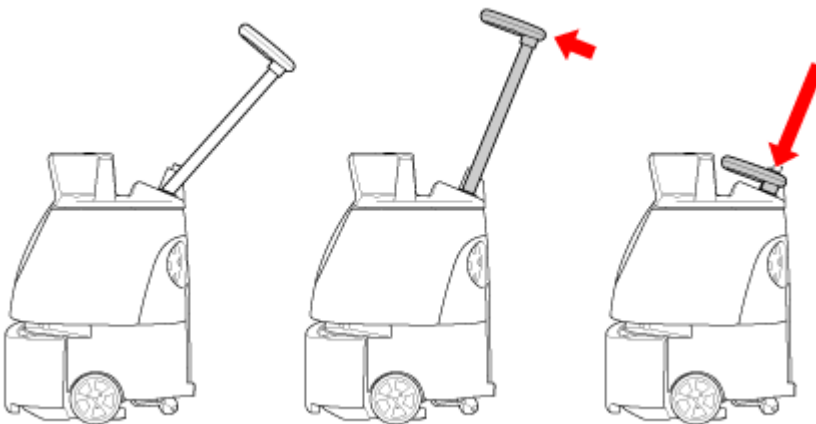

2 Hold the lift handle with one hand, and hold the steering handle down with another hand.

- Please operate with two people.

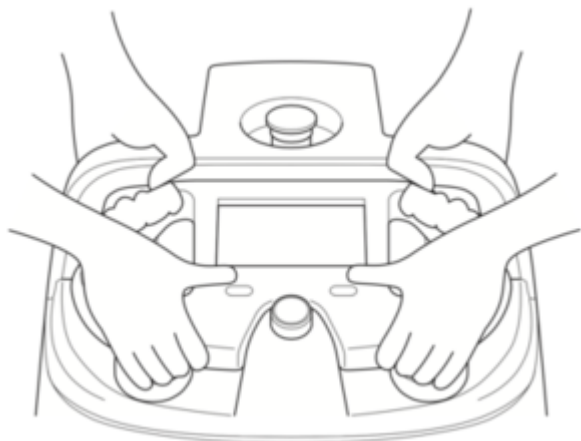

3 Gently lay the machine down so that the dustbin faces upward.

 The rubber pad will support and stabilize the machine.

- Please ensure that the steering handle does not stick out of the machine.
- Take care not to let the machine fall forcefully or to turn.
- A concrete or other hard surface will scratch the machine; place the machine on carpeting or other soft and flat surface.

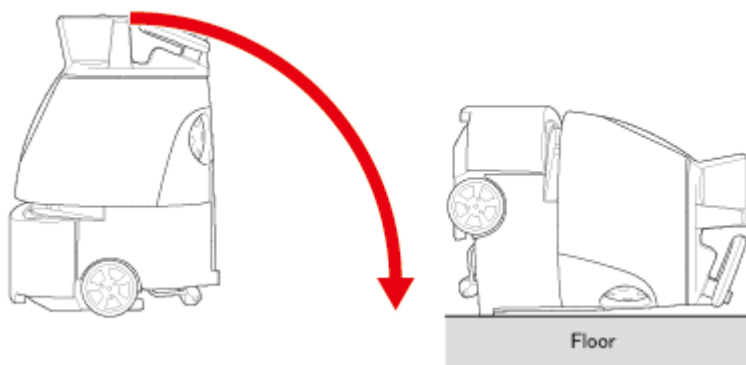

- Please check that the secondary battery power button on the bottom of the machine is off (⇒see "Secondary Battery Power Button"). Also, remove the protective film on the cliff sensor.

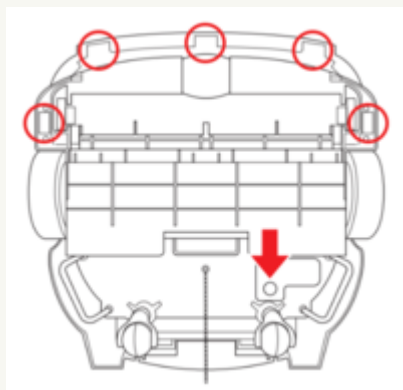

4 Check the marks on the left and right ends of the new brush

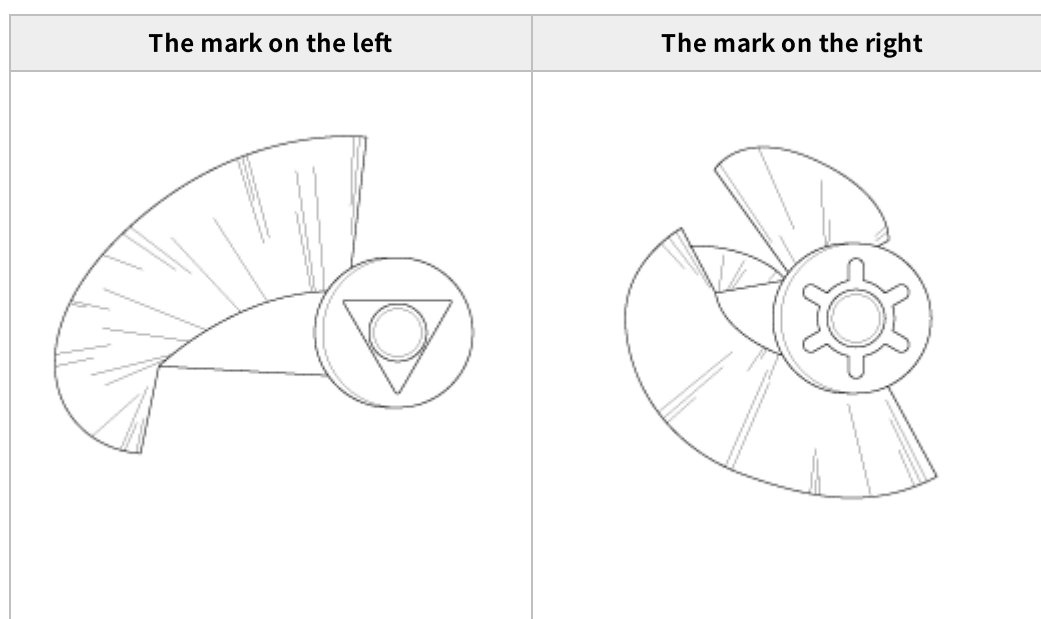

- When the machine is laid down, with the front side facing up, you will see the sockets of the brush compartment. These sockets correspond to the right and left sockets of the brush.

5 Insert the right end of the brush into the corresponding socket of the brush compartment.

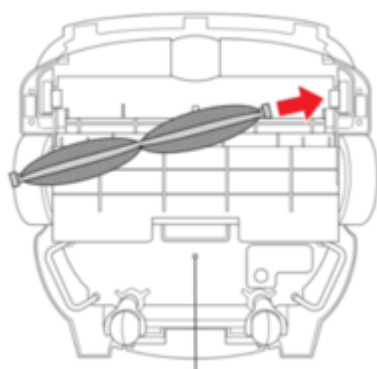

6 Push the brush in to the right, and attach the left end of the brush to the socket while aligning the same marks.

- Spin the brush and check that the marks on the left and right side of the brush are installed correctly in the socket.

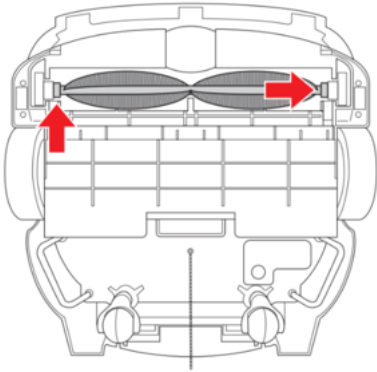

7 Hold the lift handle with one hand, and hold the steering handle down with another hand.

- Please operate with two people.

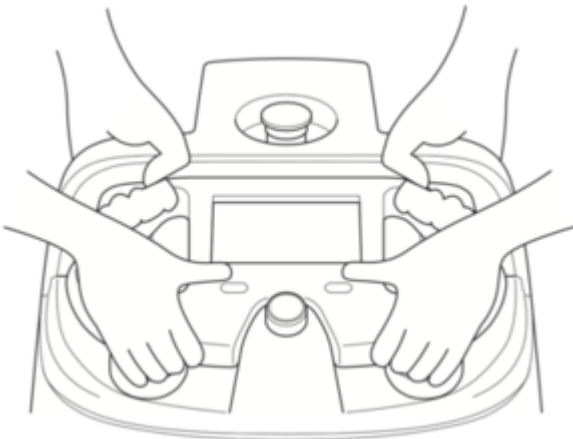

8 Holding the lift handles by each set of hands, gently raise the machine using two people

- Please ensure that the steering handle is not sticking out of the machine.

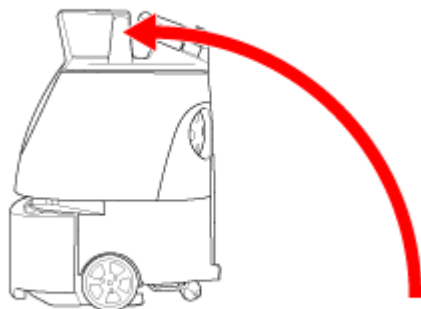

Charging the Battery and Installing it into the Machine

1 Charge the battery (⇒see "Recharging the Battery")

2 Pull the bottom left of the battery door toward you to open

- Remove the accessory box from inside the battery compartment.

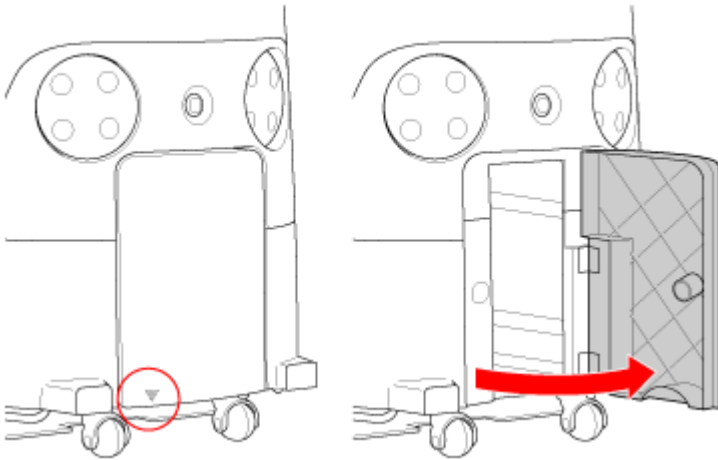

3 Insert a fully charged battery as far as it can go

 When the battery is locked in, you will hear a “click” and see the lock pop into place.

- Hold the grips by both hands, and careful not to drop the battery.
- Insert the battery in the battery compartment by its terminal end first.

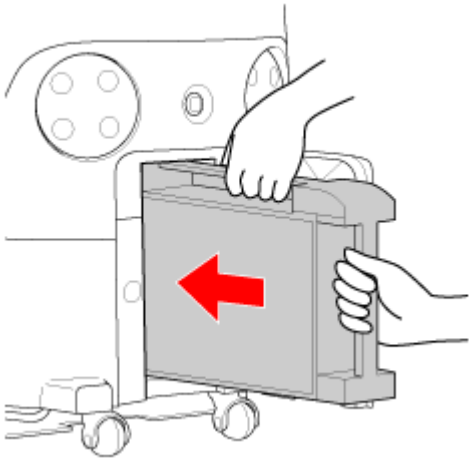

4 Check that the battery is locked

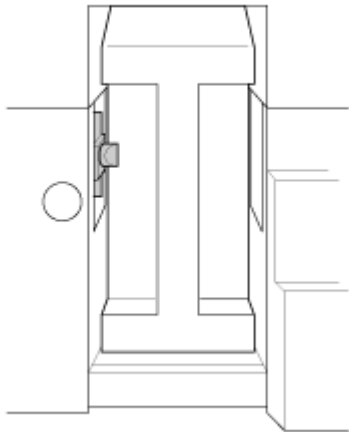

5 Close the battery door

Removing the Protective Film

1 Remove the protective film on 2D/3D Camera (sensor)

- Please be careful not to damage the sensor when removing the film.

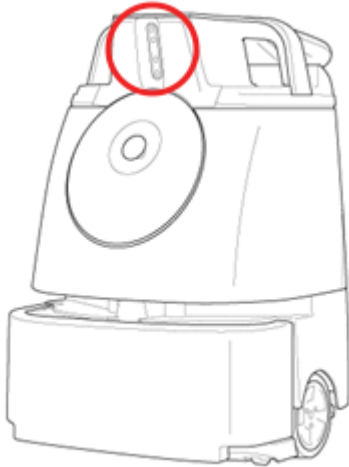

Turning the Notification Pager Power On

Before turning the power On, check that the notification pager is fully charged. If the notification pager battery is low, charge the battery fully before using the pager. (⇒See 'Recharging the Notification Pager').

1 Turn the notification pager On. (⇒See 'Turning the Notification Pager On/Off')

- After turning notification pager On, pair the pager. (⇒See 'Pairing the Notification Pager')

Connecting to Robot Operations Center (ROC)

When turning the main power switch On, the machine will automatically connect to the network and Robot Operations Center (ROC).

1 Press the main power switch (I/O) to set it on (I)

 Loading screen will be shown on the touch display.

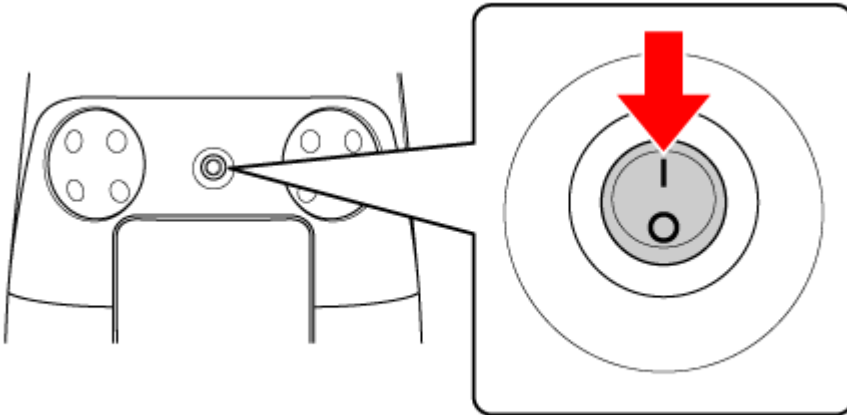

2 Check the Robot Operations Center indicator at the top right of the touch display (⇒see “Touch Display”)

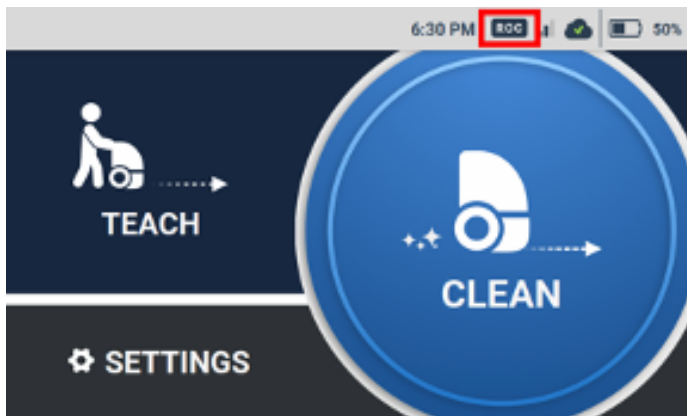

- If the ROC indicator is not displayed, move the machine to an area where the network can be connected.

Operation

Main Power Switch

Turning the Power On

- 1 Press the main power switch (I/O) to set it on (I)

 Loading screen will be shown on the touch display.

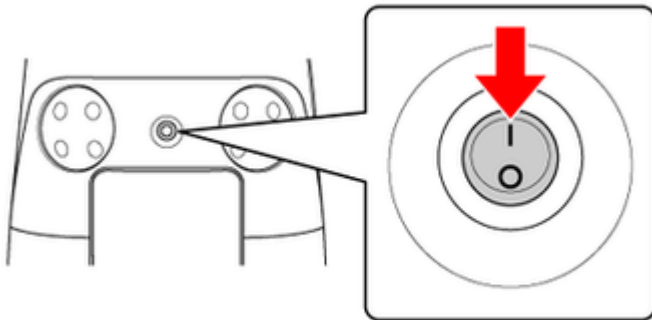

- Home screen will be displayed when the Power button is turned On. Do not turn the power Off until the Home screen is displayed.

Turning the Power Off

- 1 Press the main power switch (I/O) to set it off (O)

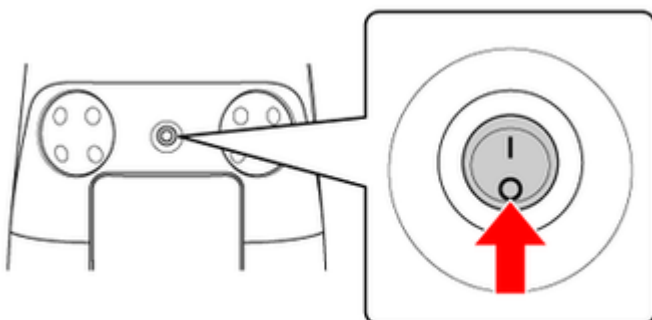

Secondary Battery Power Button

Be sure to turn off the secondary battery power button when using this machine. When replacing the battery during autonomous cleaning, turn on the secondary battery power button before replacing the battery. Autonomous cleaning can be continued without turning the power off. After replacing the battery, turn off the secondary battery power button.

- If not using the machine for a long time, turn off the Secondary Battery Power Button. (⇒see "Secondary Battery Power Button")
- If the secondary battery power is off, removing the battery while the main power switch of the machine is on may cause a malfunction.

1 Stow the steering handle (⇒see "Steering Handle")

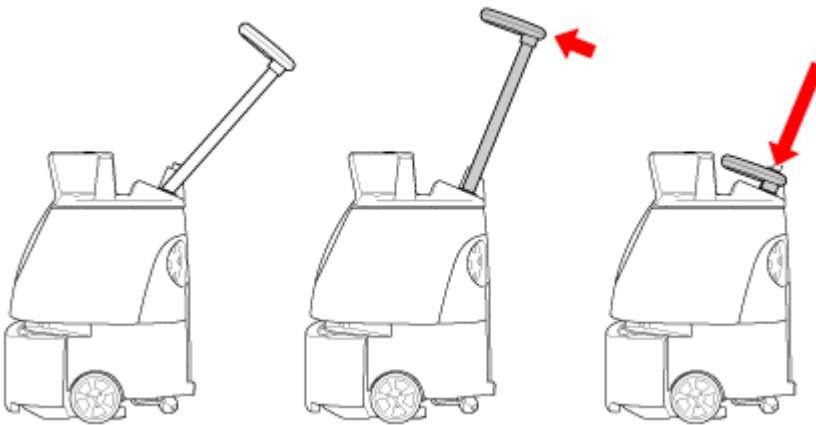

2 Hold the lift handle with one hand, and hold the steering handle down with another hand

- Please operate with two people.

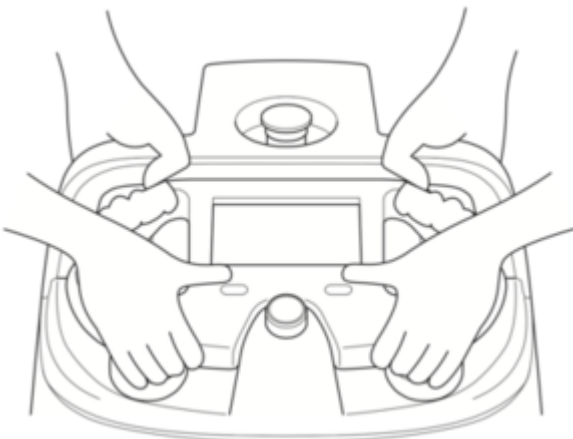

3 Hold the lift handles with both hands, and gently lay the machine on its side so that the side with the dustbin is facing upwards.



The rubber pad will support and stabilize the machine.

- Please ensure that the steering handle is not sticking out of the machine.

- Take care not to let the machine fall forcefully or to turn.
- A concrete or other hard surface will scratch the machine; place the machine on carpeting or other soft and flat surface.

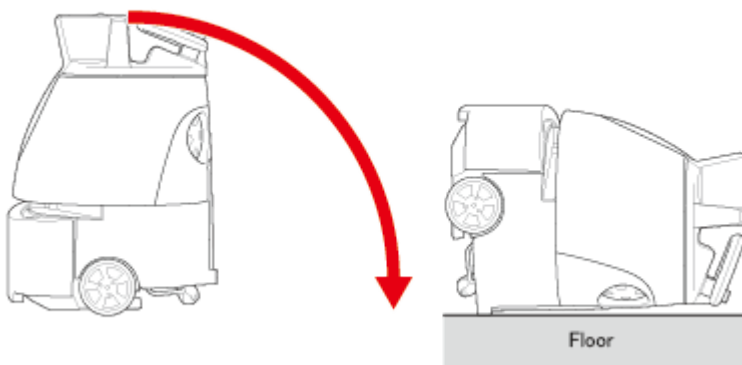

4 Press the secondary battery power button on the bottom of the machine

- When the secondary battery power button is on, the button is sunken in the machine and when it is off the button projects.

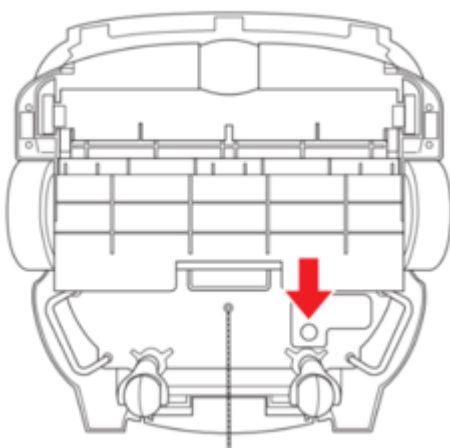

5 With two people, hold the lift handles by both set of hands and gently raise the machine.

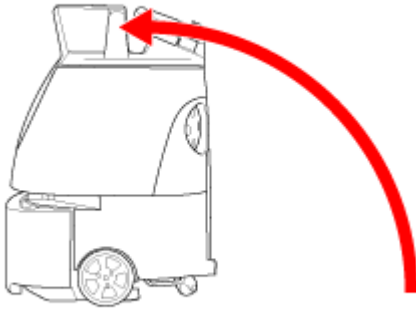

- Please operate with two people.





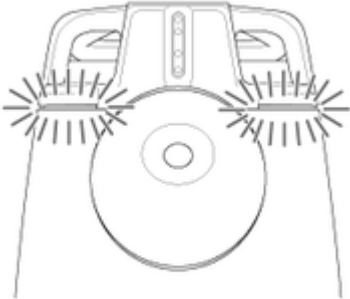

LED Lights

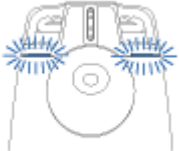
The LED lights notify you about the state of the machine, error information, etc. The LED lights on the front and back of the machine light in different colors and patterns.

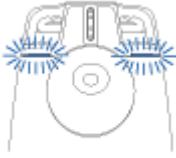
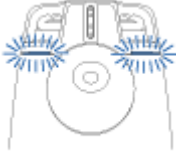

Color and pattern	Appearance	Description
Lighting in each color (green → blue → orange → red → light blue)		The machine's system is starting up.
Turning around in each color (green → blue → orange → red)		The machine is shutting down.
Lit blue		Paused during autonomous cleaning.

Color and pattern	Appearance	Description
Flashing blue rapidly for 3 seconds		Autonomous cleaning starts. Pressing the autonomous clean start/stop button causes the machine to beep.
Flashing blue slowly		Carrying out autonomous cleaning.
The left or right LED light is flashing orange rapidly		Indicating direction during autonomous cleaning. The machine turns in the direction that the LED light is flashing in. The machine beeps as it turns.
Rear LED light is flashing white		The cliff sensor was activated during autonomous cleaning, and the machine is going backward (traveling backward).
Flashing bright red rapidly		Emergency stopped.
Flashing red rapidly		An alert has occurred on the machine. (For instance, this can occur if the machine has been lifted while the system is starting up)







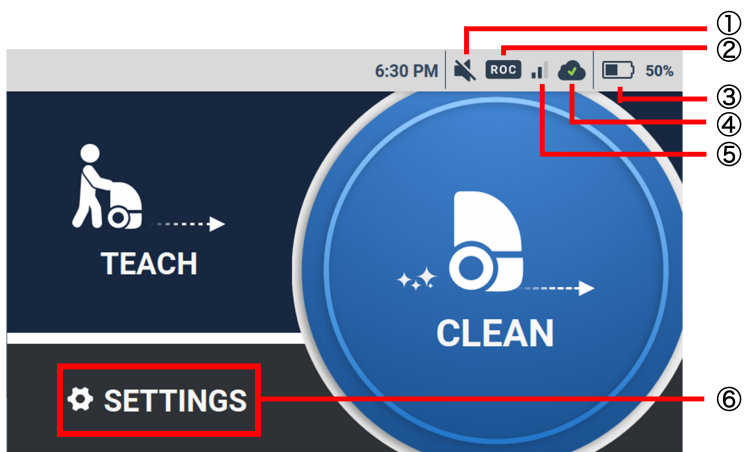





Touch Display

You can check battery level, connection to the Robot Operations Center, error messages, and other information on the touch display. Teaching and selecting of cleaning routes necessary for performing autonomous cleaning (⇒see “Autonomous Cleaning (Robot)”) are also done from the touch display.

■ Indications on the Touch Display



Main menu screen								
No.	Item	Description						
1	Mute icon	It is displayed by turning off sounds of during autonomous cleaning on Settings menu.						
2	ROC indicator	<p>A few minutes after turning the power on, the machine automatically connects to the Robot Operations Center. If the machine is connected successfully, the ROC indicator will be displayed.</p> <table border="1"> <thead> <tr> <th>ROC indicator display</th> <th>Robot Operations Center (ROC) connection status</th> </tr> </thead> <tbody> <tr> <td></td> <td>It is connected to Robot Operations Center (ROC)</td> </tr> <tr> <td></td> <td>It is not connected to Robot Operations Center (ROC)</td> </tr> </tbody> </table> <p>* To connect to the Robot Operations Center, use the machine within a communications service area for mobile phones.</p>	ROC indicator display	Robot Operations Center (ROC) connection status		It is connected to Robot Operations Center (ROC)		It is not connected to Robot Operations Center (ROC)
ROC indicator display	Robot Operations Center (ROC) connection status							
	It is connected to Robot Operations Center (ROC)							
	It is not connected to Robot Operations Center (ROC)							

Main menu screen												
3	Battery indicator	It shows the remaining battery level.										
4	Route sync icon	It shows synchronization status with the Robot Operations Center when you add or delete new cleaning routes.										
		<table border="1"> <thead> <tr> <th>Route sync icon display</th> <th>Robot Operations Center (ROC) connection status</th> </tr> </thead> <tbody> <tr> <td></td> <td>It is the status of synchronization with the Robot Operations Center (ROC) after adding or deleting cleaning routes.</td> </tr> <tr> <td> (The arrows are circling)</td> <td>The machine is synchronizing with the Robot Operations Center (ROC). A cleaning route has not been saved or deleted.</td> </tr> <tr> <td> (The arrows pause)</td> <td>The machine is not connected to the network. Synchronization with the Robot Operations Center(ROC) has been paused. Cleaning routes are not saved or deleted.</td> </tr> <tr> <td></td> <td>It is the status of being out of synchronization with the Robot Operations Center (ROC). Cleaning routes are not saved or deleted.</td> </tr> </tbody> </table>	Route sync icon display	Robot Operations Center (ROC) connection status		It is the status of synchronization with the Robot Operations Center (ROC) after adding or deleting cleaning routes.	 (The arrows are circling)	The machine is synchronizing with the Robot Operations Center (ROC). A cleaning route has not been saved or deleted.	 (The arrows pause)	The machine is not connected to the network. Synchronization with the Robot Operations Center(ROC) has been paused. Cleaning routes are not saved or deleted.		It is the status of being out of synchronization with the Robot Operations Center (ROC). Cleaning routes are not saved or deleted.
		Route sync icon display	Robot Operations Center (ROC) connection status									
			It is the status of synchronization with the Robot Operations Center (ROC) after adding or deleting cleaning routes.									
		 (The arrows are circling)	The machine is synchronizing with the Robot Operations Center (ROC). A cleaning route has not been saved or deleted.									
 (The arrows pause)	The machine is not connected to the network. Synchronization with the Robot Operations Center(ROC) has been paused. Cleaning routes are not saved or deleted.											
	It is the status of being out of synchronization with the Robot Operations Center (ROC). Cleaning routes are not saved or deleted.											
5	Signal strength icon	It shows status of network connection.										
6	Settings menu	Check settings and routes for carrying out autonomous cleaning.										

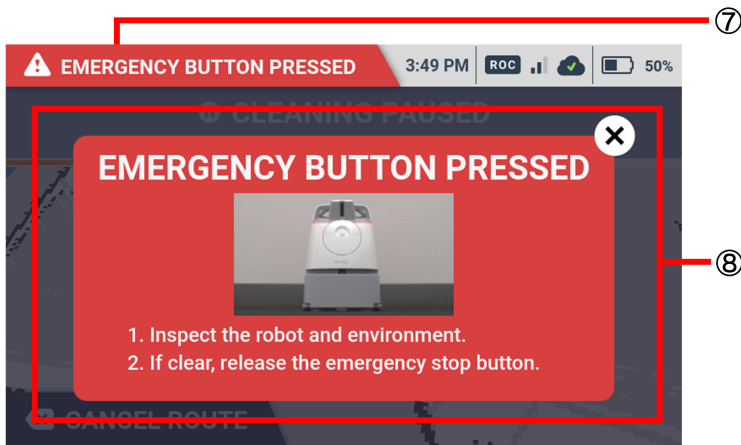

Error message screen		
No.	Item	Description
7	Notification	Appears on the upper left of the touch display. For alerts concerning machine components, follow the instructions on the touch display to remedy problems.
8	Alert screen	You can check the alert by tapping on the notification in "7". If there are several alerts, tap ">" to view the next alert. To delete the displayed alert, tap "X".

Vacuum Power Button

Press the vacuum power button to start vacuuming. Press the button again to stop vacuuming. Pressing the vacuum power button stops vacuuming in either normal mode or max power mode.

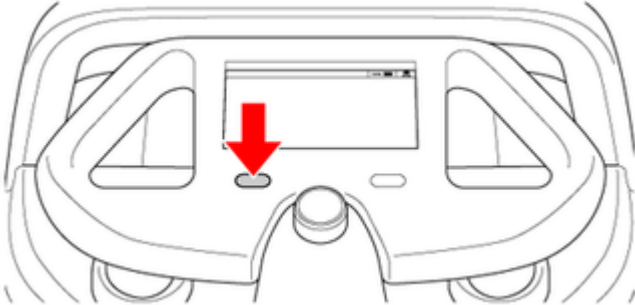

Max Power Mode Button

Press the max power mode button to change the cleaning mode from normal mode to max power mode. To clean in max power mode, check that the vacuum power button is on, and press the max power mode button. Press again to change to normal mode.

- Use max power mode for especially dirty floors.
- Max power mode uses up much more battery than normal mode. Consider cleaning time and how long the battery will be used before using this mode.
- Either mode can be used in both autonomous cleaning/manual cleaning.

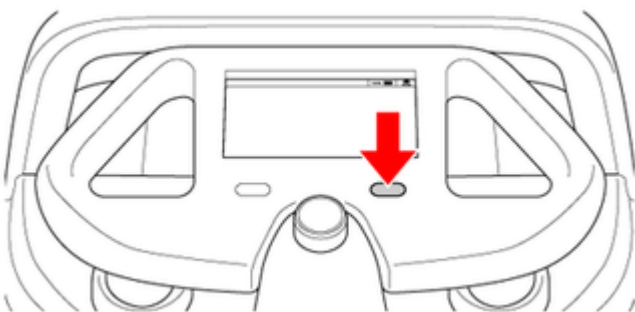

Steering Handle

Use the steering handle to move and change the direction of the machine during manual cleaning, to teach cleaning route, and to transport the machine. Observe the following when using the steering handle.

- Check if the steering handle is unstable (not firmly attached).
- Avoid abruptly turning with the steering handle.
- Do not lift the machine by the steering handle.
- The steering handle can be extended to move the machine even when the main power switch is off.
- Be careful not to pinch your fingers in the steering handle.
- Stow the steering handle before starting autonomous cleaning.

Using the Steering Handle

- Extend the steering handle to move the machine forward and to change directions. To extend the steering handle, hold with both hands and pull it straight up. Once the joint at the base of the steering handle is visible, lower the steering handle toward you.

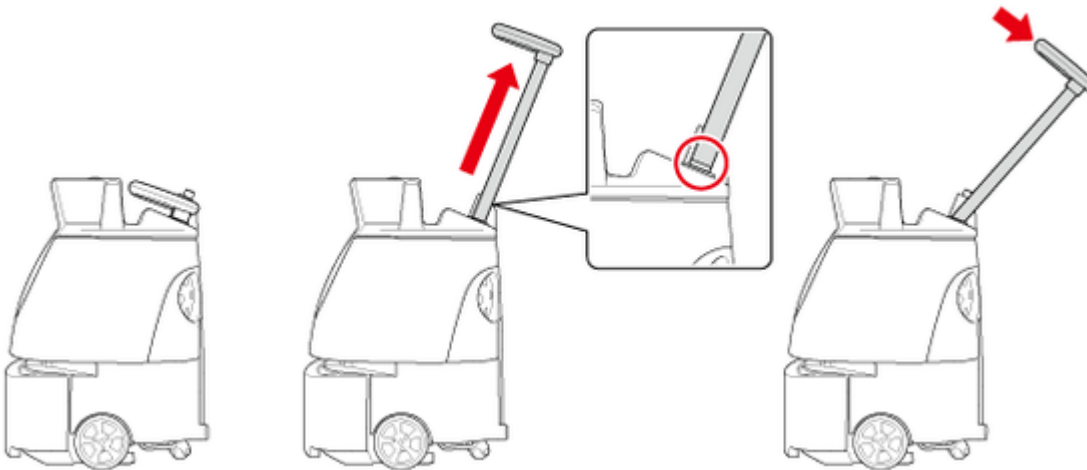

■ Stowing the Steering Handle

- To stow the steering handle, hold with both hands and raise it forward at an angle, and push it in to its original position.
- Stow the steering handle when the machine is put away or is unused for a long time.

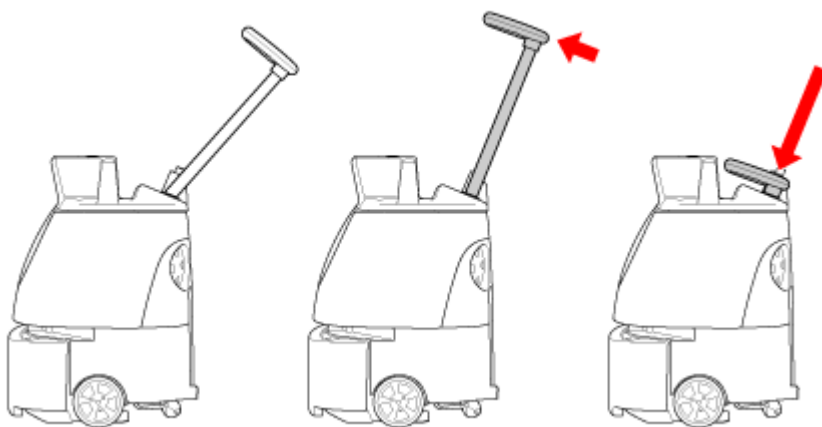

- Stowing the steering handle causes the wheels to lock. Pull the steering handle out to unlock the wheels.

■ Notification Pager

If the machine stops operating during autonomous cleaning or the battery becomes low, the notification pager (⇒see “Notification Pager”) is alerted by the machine, and the notification pager emits an alert and vibrates to notify the operator.



Autonomous Clean Start/Stop Button

Press the autonomous clean start/stop button to start autonomous cleaning mode (⇒see “Autonomous Cleaning (Robot)”), pause the machine, or restart cleaning.

- The autonomous clean start/stop button is used only in autonomous cleaning mode.

1 Press the autonomous clean start/stop button

 Autonomous cleaning starts.

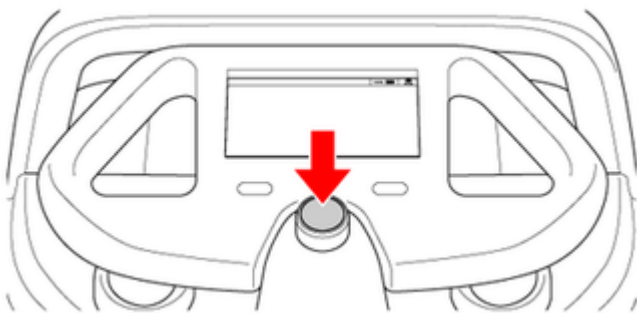

2 During autonomous cleaning, press the autonomous clean start/stop button

 The machine pauses traveling/vacuuming, and a message appears on the touch display (⇒see “Touch Display”) indicating the machine is temporarily paused.

3 Press the autonomous clean start/stop button again

 The machine unpauses, and autonomous cleaning resumes.

Inspection Before Operating the Machine

Before starting manual cleaning mode/autonomous cleaning mode, be sure to perform the following inspection.

■ Inspecting the Machine

- Check that the emergency stop button is not pressed
- Check that the grounding chain on the bottom of the machine is in contact with the floor
- Check that the secondary battery power button on the bottom of the machine is off. (⇒see “Secondary Battery Power Button”)
- Check the HEPA filters, and replace with new HEPA filters if especially dirty (⇒see “HEPA Filters”)
- Check the hopper tray is empty (⇒see “Hopper Tray”)
- Check that there is no dust or dirt on the 2D/3D camera (sensor), LIDAR sensor, or Cliff sensor and wipe as required (⇒see “Sensors”)
 - Use the micro-fiber cloth to wipe away any dust or dirt.
 - * Do not wet any of the sensors or the micro-fiber cloth mentioned above, with water.
 - Do not place any objects near the sensors.
- Check the brush for caught dust and hair, and remove as required (⇒see “Brush”)
- Check that the brush is attached properly
 - If the brush is damaged/broken, replace with a new brush.
- Check that the dustbin cover, filter cover, and battery door are closed firmly

■ Inspecting the Cleaning Area

- Check that the cleaning area is an environment where cleaning is possible
 - The machine is not water resistant. Use the machine in a dry location.

Autonomous Cleaning (Robot)

Overview

The machine is capable of automatically cleaning on a saved cleaning route (autonomous cleaning mode). To clean in autonomous cleaning mode, you must first teach a cleaning route either automatically (⇒see “Teaching a Cleaning Route Automatically”) or manually (⇒see “Teaching a Cleaning Route Manually”) and with the machine scan the Home Location Code you have created (⇒see "Home Location Codes"). Select a cleaning route you taught to start autonomous cleaning.

- Always inspect the machine (⇒see “Inspection Before Operating the Machine”) before operating in autonomous cleaning mode. Take proper precautions when teaching cleaning routes. (⇒see “Checking Precautions when Teaching a Cleaning Route”).

FCC Compliance Statement

Note:

This equipment has been tested and found to comply with the limits for a Class A digital device, pursuant to part 15 of the FCC Rules. These limits are designed to provide reasonable protection against harmful interference when the equipment is operated in a commercial environment. This equipment generates, uses, and can radiate radio frequency energy and, if not installed and used in accordance with the instruction manual, may cause harmful interference to radio communications. Operation of this equipment in a residential area is likely to cause harmful interference in which case the user will be required to correct the interference at his own expense.

This equipment (**FCC ID: 2AT19-A00000101A01**) complies with FCC radiation exposure limits set forth for an uncontrolled environment. End users must follow the specific operating instructions for satisfying RF exposure compliance requirements. This transmitter must not be co-located or operating in conjunction with any other antenna or transmitter.

Home Location Codes

Home Location Codes are markers indicating where cleaning routes start and stop. They are used for establishing the machine's home location, and according to the size of the cleaning area, one or several Home Location Codes are used (6 cleaning routes can be saved for 1 Home Location Code). In a building with several floors, a Home Location Code specific to each floor must be placed.



■ Locations for Placing Home Location Codes

Place Home Location Codes on walls, columns, etc. near areas that are frequently cleaned.

- The back of Home Location Codes is sticky, allowing them to be placed directly on walls, etc. Replace with new Home Location Codes if they have lost their stickiness. Depending on the wall material, the coating may peel where Home Location Codes are placed. Consult with the building manager and place Home Location Codes in appropriate locations. Do not place on walls with rough surfaces.
- Place Home Location Codes on walls, columns, etc. in a bright location and distanced approximately 60 cm (2.0ft) from the floor and approximately 80 cm (2.6ft) from the machine.

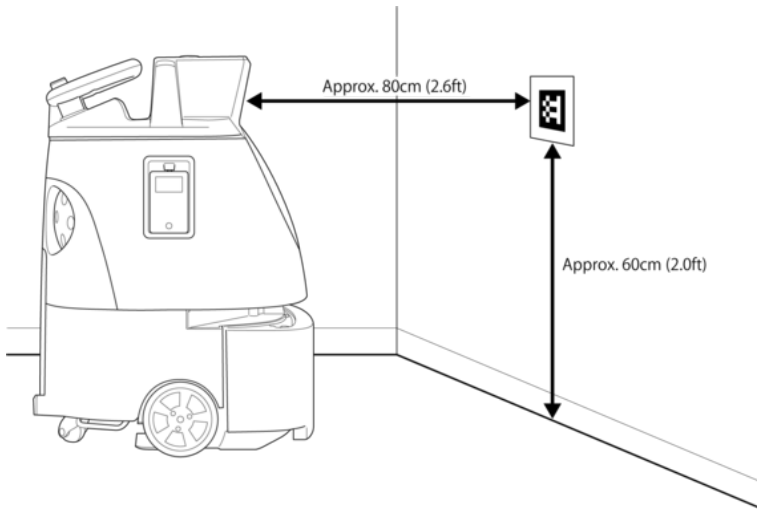

- Do not place Home Location Codes where they may be hidden, such as walls behind furniture or shelves.
- Ensure that all Home Location Codes are placed neatly in a horizontal fashion, and not in a manner that is askew; set the home location code horizontally and a little below the camera, placed in front of the machine.
- Do not place Home Location Codes in a sleeve or cover, and do not copy on them or laminate them. The machine may not be able to scan the Home Location Codes.
- Avoid locations exposed to sunlight or strong light, and set them where brightness is even.
- Leave Home Location Codes always set out. If unable to leave Home Location Codes always set out, you must place them accurately in the same positions each time you clean. If the set locations of Home Location Codes are even slightly shifted, cleaning will not be done correctly.

■ Scanning Home Location Codes

Home Location Codes are scanned with the camera on the front of the machine (⇒see “Names of Parts”).

- Move the machine to where the distance between the camera and a Home Location Code is approximately 80 cm (2.6ft), and stop the machine so that the Home Location Code and machine are parallel. If the machine is not positioned properly, it cannot scan the Home Location Code.
- Once the machine has scanned the Home Location Code, a screen for selecting cleaning routes appears on the touch display.

Group Function and Cleaning Routes

The machine communicates with the Robot Operations Center (ROC) and taught cleaning routes are saved to the cloud.

By assigning multiple robots to the same group on the Whiz Connect Portal*, the robots can share cleaning routes. When one robot scans the Home location code, all the robots display the same cleaning route. Deleting cleaning routes also deletes them from the cloud. The deleted cleaning routes will no longer be displayed even if another robot in the same group scanned the Home location code.

*The Whiz Connect Portal is a portal site from where you can manage current machine activity and alerts, download activity reports, create a new group, assign a Robot, and edit or delete created Group names. For more details, see “Whiz Connect User Guide”.

*By default, the robots are not assigned to any group.

Precautions when Teaching a Cleaning Route

Be sure to do the following before teaching a cleaning route.

Machine

- Always carry out an inspection before operating the machine (⇒see “Inspection before Operating the Machine”).
- Do not bring the machine too close to a wall when teaching a cleaning route.
- Do not stand in front of the sensor, because the machine may detect nearby people as objects. Teach cleaning routes at times when few people are around.
- Do not use the machine where there is direct sunlight, where there is strong lighting, or near devices that emit infrared light (heaters, etc.). Doing so may affect its autonomous cleaning function.
- When teaching a cleaning route, move the machine forward. *Reverse movement will not be recognized as a cleaning route.
- The machine will push against thin mats that slide easily, and may damage the mat or brush. Remove any mats before teaching a cleaning route.
- Floors with an uneven, rough surface cannot be detected during auto cleaning. As bumpy floors may be recognized as obstacles, avoid cleaning rough-surface floors.
- A passageway of more than 80cm (2.6ft) in width is needed in order for Whiz to operate autonomously at an optimum speed.
*If the width of the passageway is below 80cm (2.6ft), the machine may recognize an obstacle and the speed may decrease or the machine may stop.
- When operating several machines, their sensors may cross-interfere with each other.

■ Cleaning Routes

- When teaching a cleaning route, divide the area into zones using floor material and stepped portions as boundaries.
- The recommended cleaning route area per one cleaning is about 500 m² (5500 ft²) when teaching a cleaning route manually (see “Teaching a Cleaning Route Manually”). A cleaning route of over 500 m² (5500 ft²) may have obstacles that could cause the machine to stop during autonomous cleaning or that could prevent the machine from saving the cleaning route.

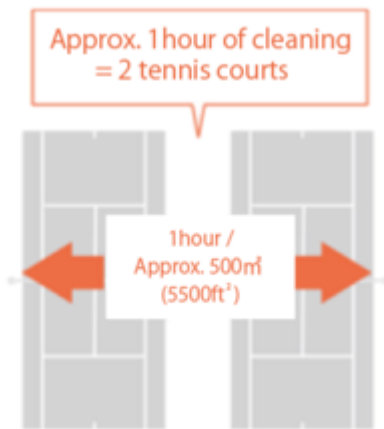

- Remove any obstacles, cables, etc. from the cleaning route that could be a hindrance to cleaning. If the machine detects an obstacle during autonomous cleaning and slows down/stops, it may be unable to completely clean away all dirt.
- Please do not include any of the following locations in the cleaning route. If there are any obstacles, please remove them in advance.

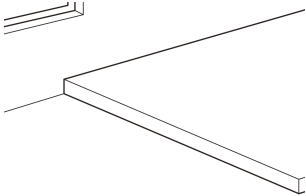
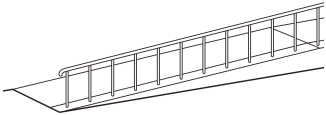
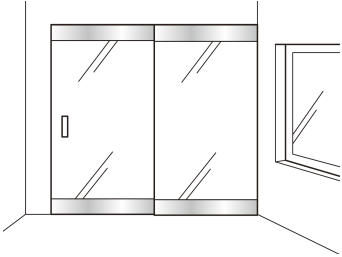
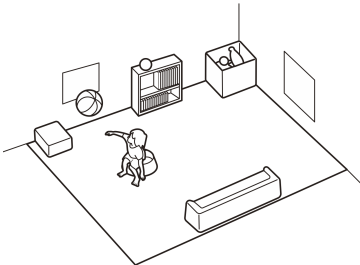
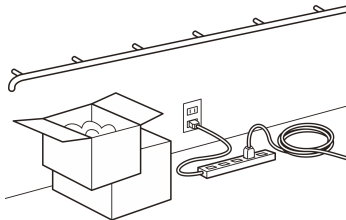
Prohibited locations	Specific Examples
<p>Areas with steps higher than 1.5 cm</p> 	<ul style="list-style-type: none"> Grooves between floors, drainage lids, gratings Around elevators or escalators Braille blocks or thick rugs
<p>Angled surface</p> 	<p>Slopes etc.</p>
<p>Areas with reflective objects</p> 	<p>Areas with automatic doors or around reflective objects such as windows or mirrors. *An error may occur when cleaned autonomously. Please clean the area manually.</p>
<p>Areas where a person may suddenly pop out in front of the machine</p> 	<p>Kids corner etc.</p>
<p>Areas with obstacles</p> 	<p>Decorations hung from the wall, handrails, slippers, cords, retractable outlets, etc.</p>

- If the cleaning area is exposed to direct sunlight or strong light, close curtains and blinds to block out light.
- Use manual cleaning in the vicinity of automatic doors, window glass, and reflective products such as mirrors.
 - * An error may occur if autonomous cleaning is used.
- Some objects laying on a floor may not be detected as obstacles depending on their size (slippers, cords, retracting electrical outlets). Remove any such objects before teaching a cleaning route.
- For a cleaning area with objects such as pillars etc., teach a cleaning route manually.
- Since the machine may not be able to avoid places where people suddenly pop out in front of the machine (such as areas where children are present), decorations hung from a wall, handrails, etc., please do not include it in the cleaning route or remove them from the route beforehand.
- Also see "Sensor Detection Range".

■ Robot Operations Center (ROC)

- Before using the machine, please confirm the user's LTE connection. The machine will not be able to connect to ROC in an environment with no LTE connection.

■ Notification pager

- To allow the notification pager to receive alert messages from the machine, perform pairing with the notification pager (⇒see "Notification Pager").

■ Teaching and Saving a Cleaning Route

- Before teaching a cleaning route, check “Precautions when Teaching a Cleaning Route”.

1 Pull the steering handle up as far as it will go, and lower it toward you

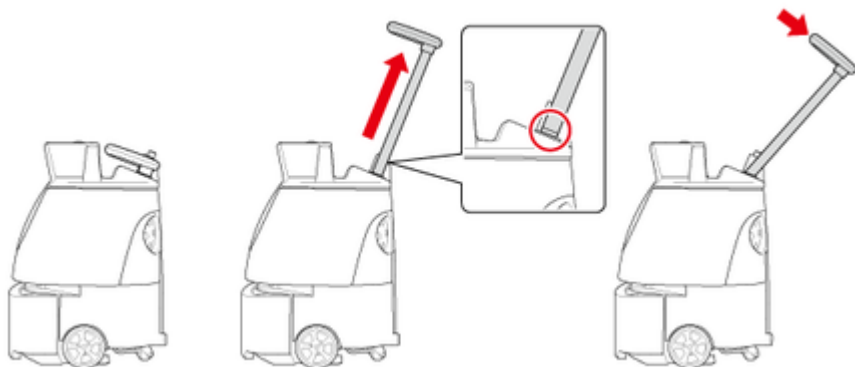

2 Move the machine to the Home Location Code where cleaning is to be carried out (⇒see “Home Location Codes and Cleaning Routes”)



3 Press the main power switch (I/O) to set it on (I)

- 🚩 A screen appears on the touch screen (⇒see “Touch Display”) for selecting “TEACH ROUTE/RUN ROUTE/SETTINGS”.

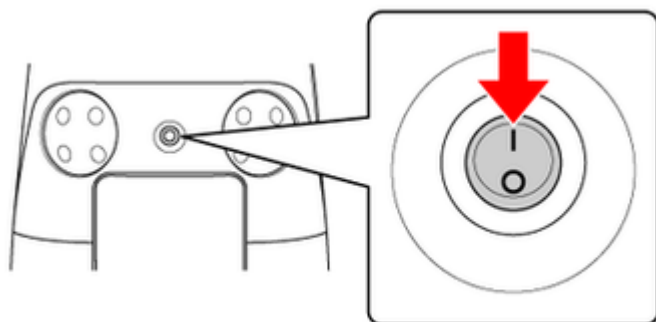

4 On the touch display, tap “TEACH”

A screen for scanning a Home Location Code appears.(⇒see “Home Location Codes and Cleaning Routes”).

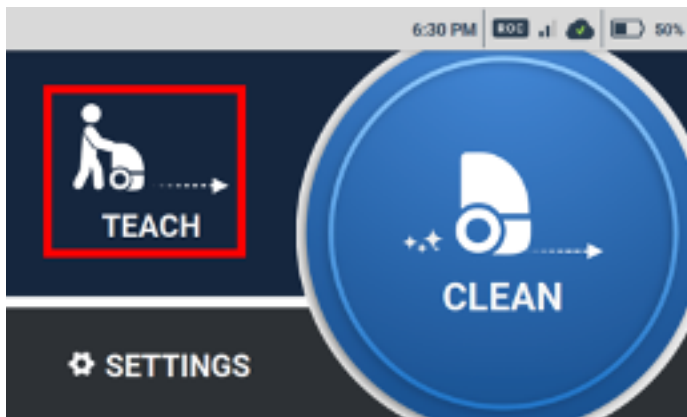

5 Place the machine so that the machine’s sensor and the Home Location Code are parallel, and scan the Home Location Code

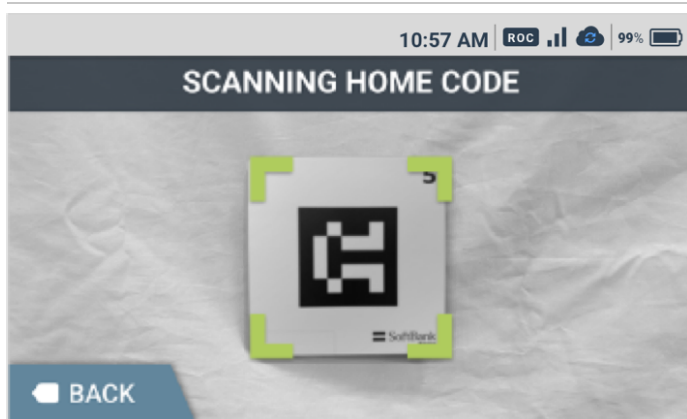

- When the machine has scanned the Home Location Code correctly, a green frame appears. Otherwise, a red frame appears. Check that the Home Location Code is placed in the correct location (⇒see “Home Location Codes and Cleaning Routes”), or that the Home Location Code and machine are distanced about 80 cm (2.6ft) apart.

6 Select for where to save cleaning route

 The selected spot is assigned to the new cleaning route.

- Once the number of saved routes has reached the limit, either delete existing cleaning routes (⇒see “Deleting Cleaning Routes”), or scan a different Home Location Code.

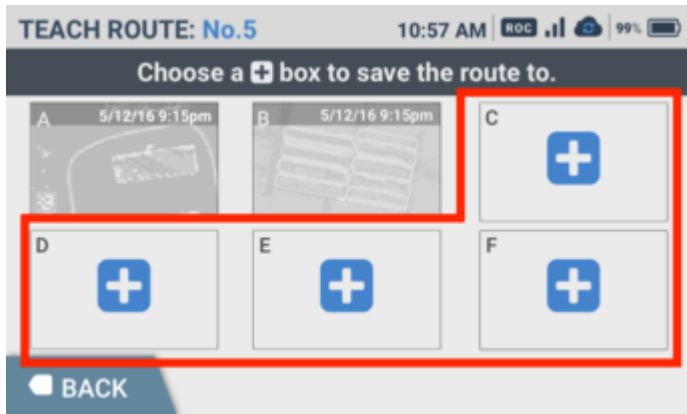

7 Tap “TEACH ROUTE”

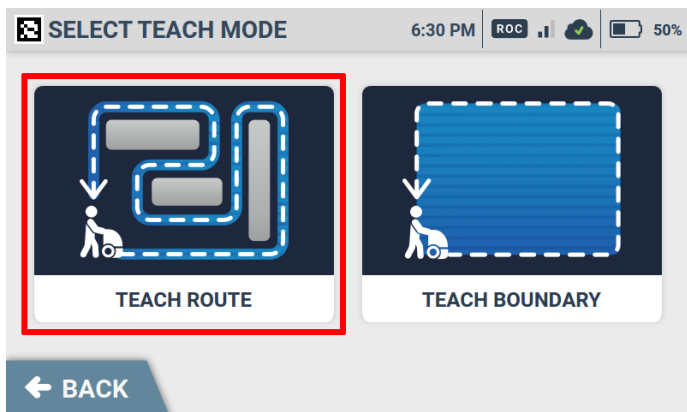

8 Press the vacuum power button (⇒see “Vacuum Power Button”)

- If the floor is in a very bad condition, use Max power mode (⇒see "Max Power Mode Button").

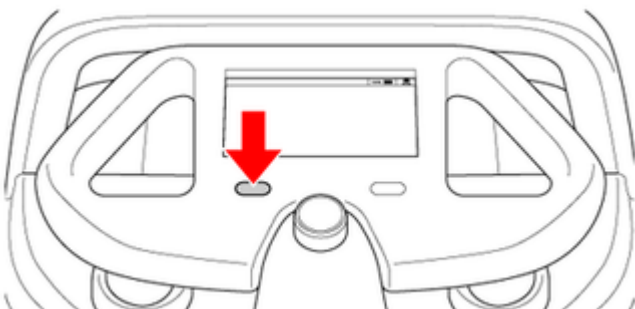

9 Use the steering handle to move the machine, and clean the entire cleaning route (teaching route)

- Changing between normal mode and max power mode (⇒see “Max Power Mode Button”) is also learned in a cleaning route.
- Teaching a cleaning route with few detours allows the machine to travel with fewer decreases in speed for more efficient cleaning.
- The speed at which the machine travels as you are cleaning along the cleaning route (teaching route) has no effect on automatic travel. Clean at your own pace, stopping to check the cleaning route, etc. as needed.
- Be sure to move the machine forward. Backward movement is not learned in a cleaning route.
- Do not lift the machine up from the floor while teaching a cleaning route.
- Do not abruptly stop other than for an emergency. Suddenly turning the machine or changing directions while teaching a cleaning route may affect the teaching of the cleaning route. Make sure the machine travels in as straight a direction as possible.
- To cancel cleaning route teaching, pause the machine, and on the touch display, tap “CANCEL ROUTE” → “YES - CANCEL”.



10 Press the Vacuum power button

 Cleaning mode will turn off.

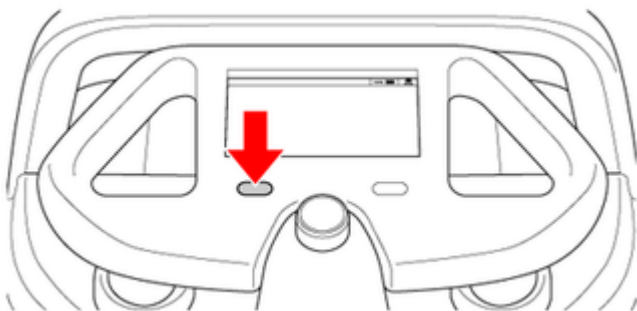

11 Return to the Home Location Code scanned at procedure 5



12 Scan the Home Location Code

 The cleaning route is saved.

- The saved route appears in the “RUN ROUTE” menu.

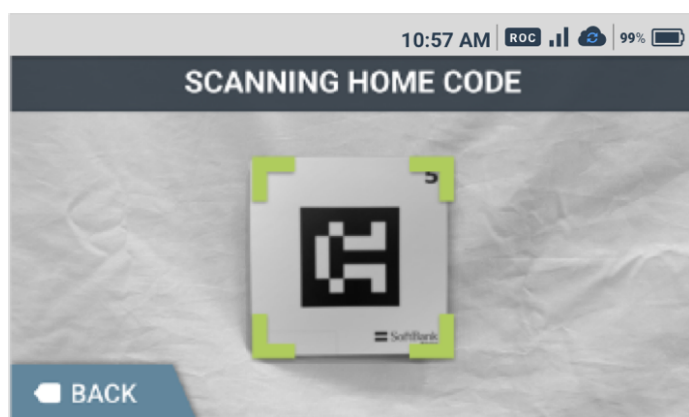

Teaching a Cleaning Route Automatically

You can create a cleaning route automatically by only training the perimeter of the cleaning area (within specified limitations).

- Before teaching a cleaning route, check “ Precautions when Teaching a Cleaning Route”.

1 Pull the steering handle up as far as it will go, and lower it toward you

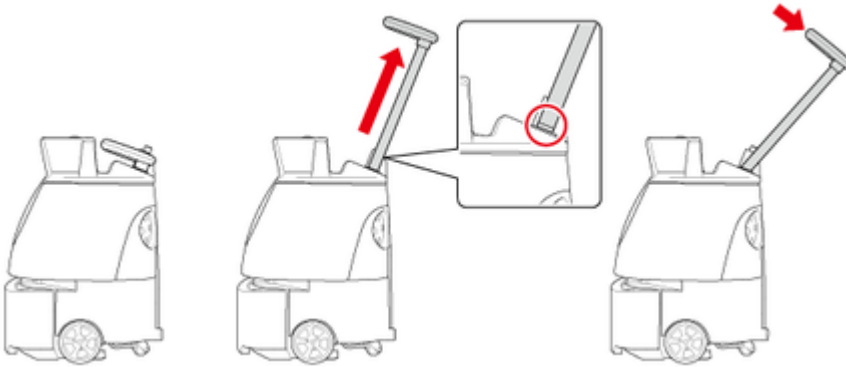

2 Move the machine to the Home Location Code where cleaning is to be carried out (⇒see “Home Location Codes and Cleaning Routes”)



3 Press the main power switch (I/O) to set it on (I)

 A screen appears on the touch screen (⇒see “Touch Display”) for selecting “TEACH ROUTE/RUN ROUTE/SETTINGS”.

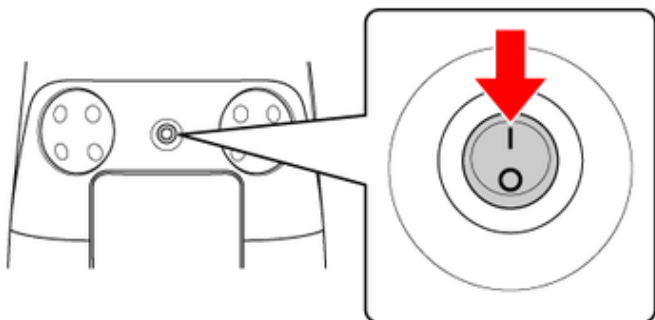

4 On the touch display, tap “TEACH”

 A screen for scanning a Home Location Code appears.(⇒see “Home Location Codes and Cleaning Routes”).

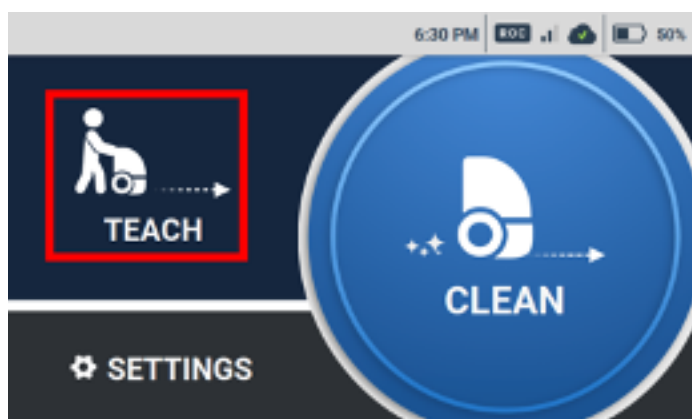

5 Place the machine so that the machine's sensor and the Home Location Code are parallel, and scan the Home Location Code

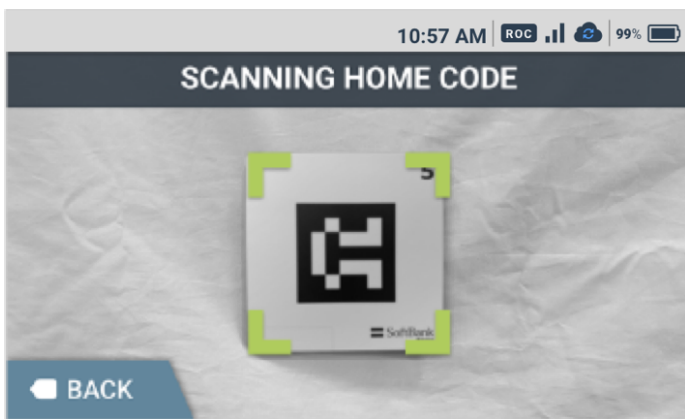

- When the machine has scanned the Home Location Code correctly, a green frame appears. Otherwise, a red frame appears. Check that the Home Location Code is placed in the correct location (⇒see “Home Location Codes and Cleaning Routes”), or that the Home Location Code and machine are distanced about 80 cm (2.6ft) apart.

6 Select **+** for where to save cleaning route

 The selected spot is assigned to the new cleaning route.

- Once the number of saved routes has reached the limit, either delete existing cleaning routes (⇒see “Deleting Cleaning Routes”), or scan a different Home Location Code.

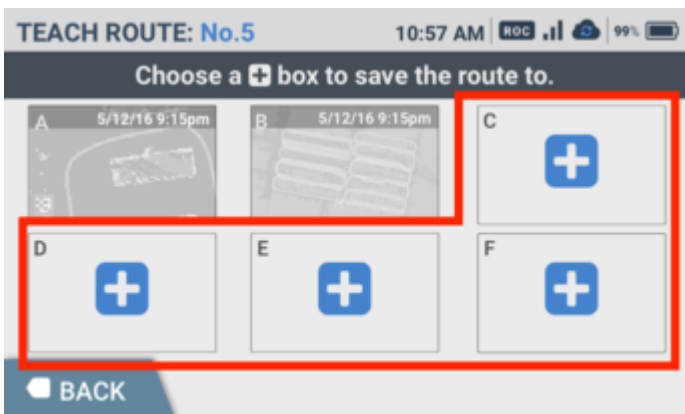

7 Tap “TEACH BOUNDARY”

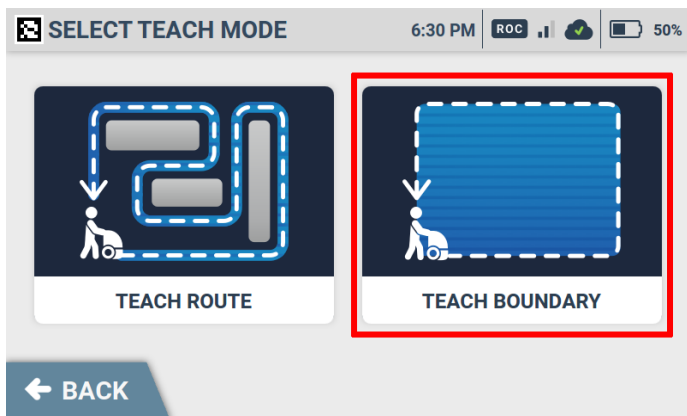

8 Press the vacuum power button (⇒see “Vacuum Power Button”)

- If the floor is in a very bad condition, use Max power mode (⇒see "Max Power Mode Button").
- When teaching a boundary with the Vacuum power off, the entire cleaning area will be cleaned in normal mode after autonomous cleaning starts.

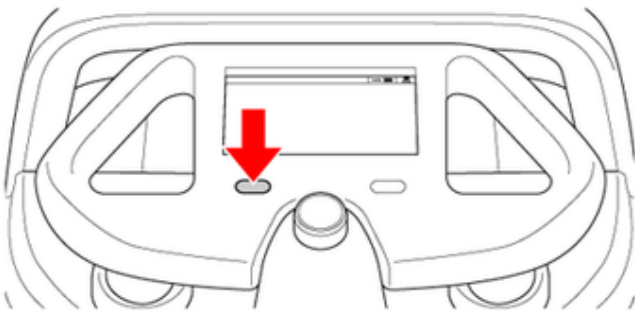

9 Use the steering handle to move the machine, and clean the boundary of the cleaning area (teaching route)

- Clean around the boundary once so that one side of the perimeter of the cleaning area is 10m or less and another side is 100m or less.
- Do not circle around the boundary or run the same place multiple times.
*Loops, concentric circles and other complex shapes that cross paths are not suitable to teach a boundary.
- Do not include places with obstacles such as a pillar in a cleaning area or its perimeter.
- Teach a cleaning route in cleaning mode of when carrying out autonomous cleaning (see “Carry Out Autonomous Cleaning”). However, even when teaching is carried out in normal mode, by turning the max power mode on during autonomous cleaning (see “Max Power Mode Button”), the autonomous cleaning is carried out in max power mode.

Cleaning mode of when teaching a route	Cleaning mode during autonomous cleaning
The vacuum button off	Normal mode
Switch from the vacuum button off to normal or max power mode	Normal mode or max power mode
Switch from normal mode to max power mode	Max power mode

* Even if the cleaning mode is switched while teaching a cleaning route, once the max power mode is used, all cleaning will be performed in max power mode during autonomous cleaning.

- The speed at which the machine travels as you are cleaning along the cleaning route (teaching route) has no effect on automatic travel. Clean at your own pace, stopping to check the cleaning route, etc. as needed.
- Be sure to move the machine forward. Backward movement is not learned in a cleaning route.
- Do not lift the machine up from the floor while teaching a cleaning route.
- Do not abruptly stop other than for an emergency. Suddenly turning the machine or changing directions while teaching a cleaning route may affect the teaching of the cleaning route. Make sure the machine travels in as straight a direction as possible.
- To cancel cleaning route teaching, pause the machine, and on the touch display, tap “CANCEL ROUTE” → “YES - CANCEL”.



10 Press the Vacuum power button

 Cleaning mode will turn off.

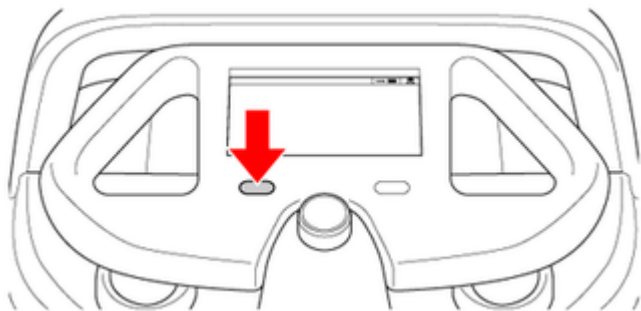

11 Return to the Home Location Code scanned at procedure 5



12 Scan the Home Location Code

 The cleaning route is saved.

- The saved route appears in the “RUN ROUTE” menu.

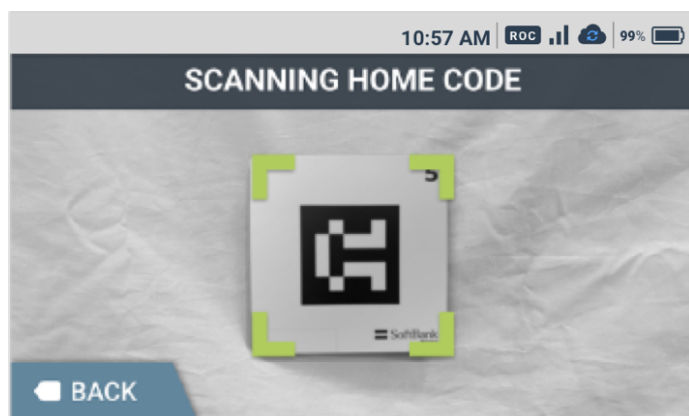

Carrying Out Autonomous Cleaning

Select a previously taught cleaning route to start autonomous cleaning (⇒see “Teaching a Cleaning Route Manually” or “Teaching a Cleaning Route Automatically”) and carry out autonomous cleaning. Before carrying out autonomous cleaning, always inspect the machine (⇒see “Inspection Before Operating the Machine”).

- Carry out autonomous cleaning at a time with the fewest number of people passing through and the least number of objects nearby.
- To allow the notification pager to receive alert messages from the machine, perform pairing with the notification pager beforehand (⇒see “Notification Pager”).
 - * Pairing is not required at every startup.
- In order to keep a safe distance from the wheel, the machine will operate slightly far from the wall. When cleaning areas close to the wall, operate manually. (⇒see "Manual Cleaning").

1 Move the machine to a Home Location Code (⇒see “Home Location Codes and Cleaning Routes”)



2 On the touch display (⇒see “Touch Display”), tap “CLEAN”



Home Location Code scanning screen will be displayed.

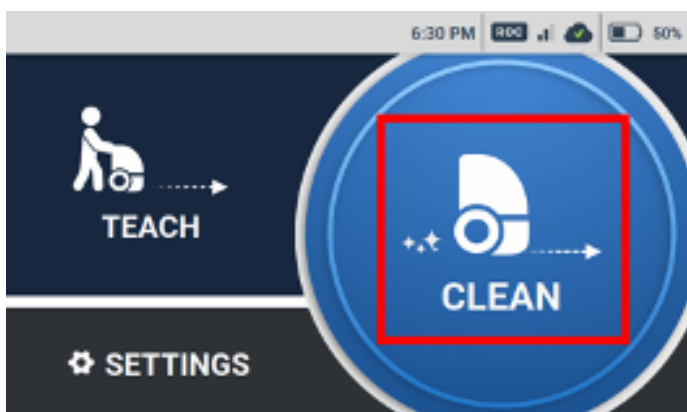

3 Scan the Home Location Code

When the Home Location Code is recognized correctly, it will turn green, and a screen for selecting a route will appear on the touch display.

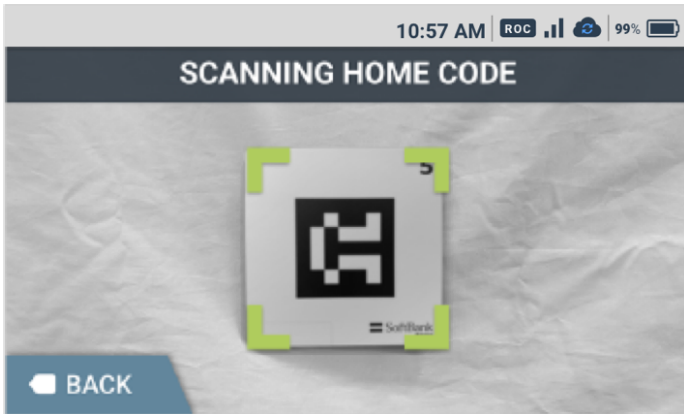

4 On the touch display, select cleaning ROUTE/AREA

- The background color of the date is gray for teach a route and is blue for teach a boundary.

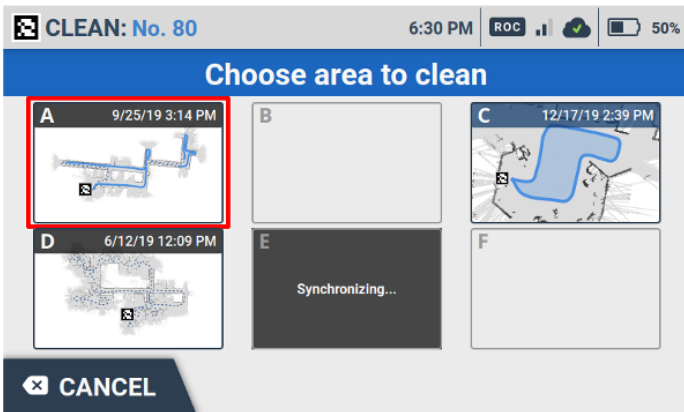

5 Stow the steering handle

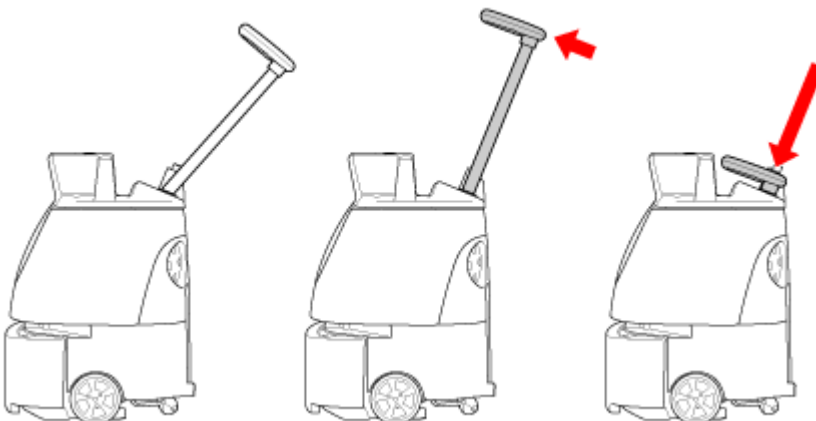

6 Remove the notification pager from the machine (⇒see “Notification Pager”)

7 Press the autonomous clean start/stop button (⇒see “Autonomous Clean Start/Stop Button”)

 Autonomous cleaning begins.

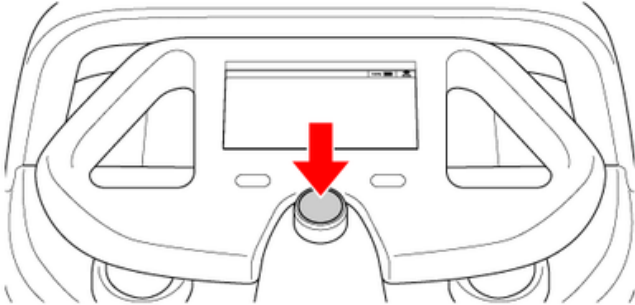

- Remove the notification pager (⇒see “Notification Pager”) from the machine and carry it with you.
- During autonomous cleaning, the LED light flashes orange twice in the direction the machine is turning. (example: when the machine is going to turn right, the LED light on the right side will flash).
- During autonomous cleaning, the machine travels somewhat away from the edges of walls at a certain distance so as not to scratch walls, etc. Use manual cleaning to clean the edges of walls (⇒see “Manual Cleaning”).
- During autonomous cleaning, do not stand in front of the LIDAR sensor.

8 Check that all functions are operating properly

- Once autonomous cleaning completes, the machine returns to the Home Location Code, and notification arrives on the notification pager.

9 The pager will notify you when cleaning is completed.

10 Check “CLEANING COMPLETE”, and tap “HOME”.



Return to the main menu screen.

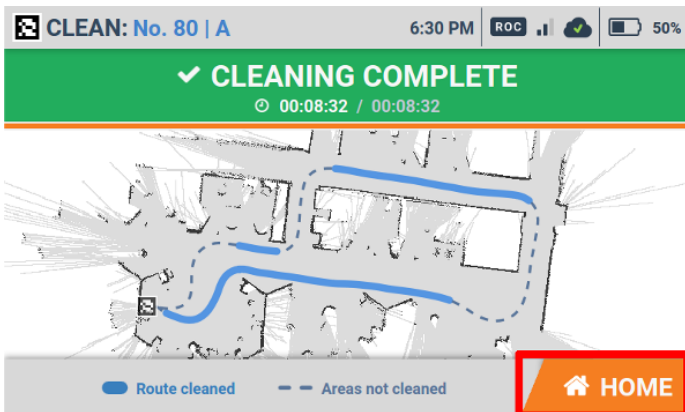

- After autonomous cleaning is completed, the cleaning status for cleaning route/area is displayed.
[Teach route] cleaning complete area: blue, incomplete area: white
[Teach boundary] cleaning complete area: blue, incomplete area: “- - -”
- Make sure to turn the machine off and charge the battery after use.
- For maintenance and storage after use, see “Maintenance and Safety”.

Deleting Cleaning Routes

- 1 On the touch display, tap “SETTINGS”

 The settings menu appears.

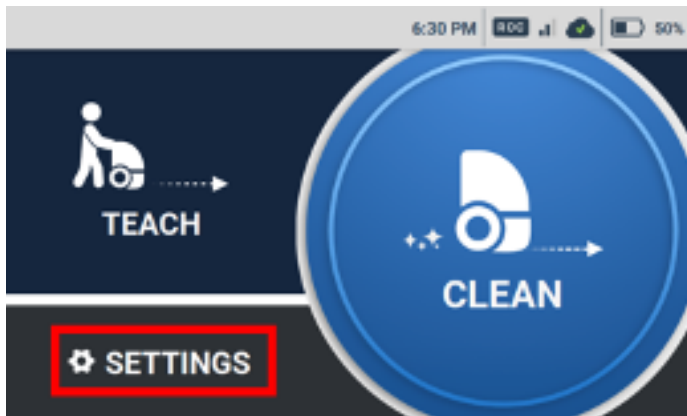

- 2 Tap “ROUTES”

 A list of saved Home Location Codes appears.

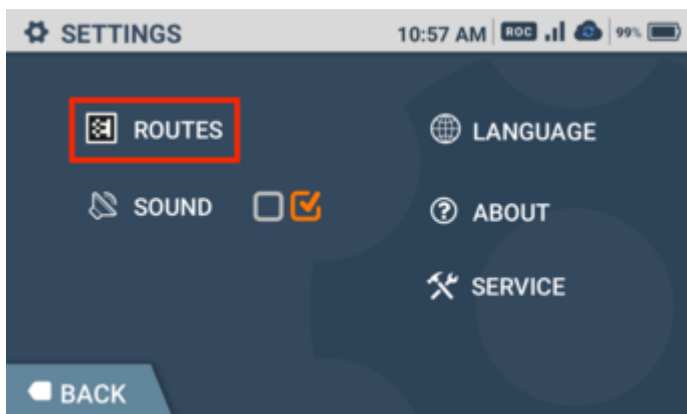

3 Select the Home Location Code with the ROUTE/AREA to delete

A list of cleaning routes/areas appears.

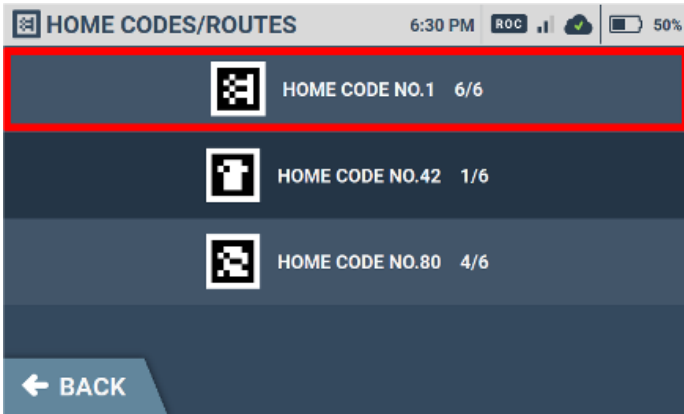

4 Select a cleaning ROUTE/AREA to delete.

The selected cleaning route/area is checked.

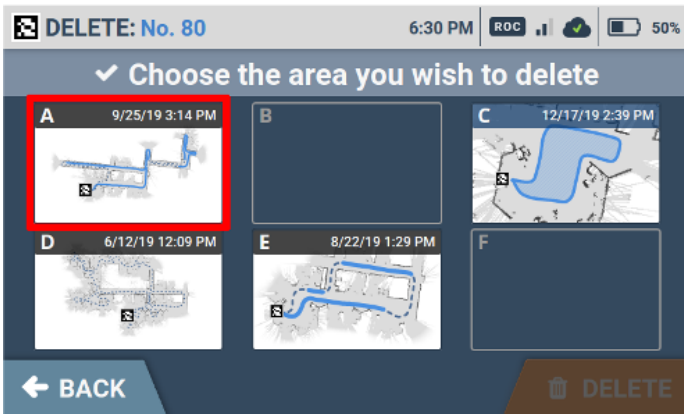

5 Tap "DELITE"

The confirmation is displayed.

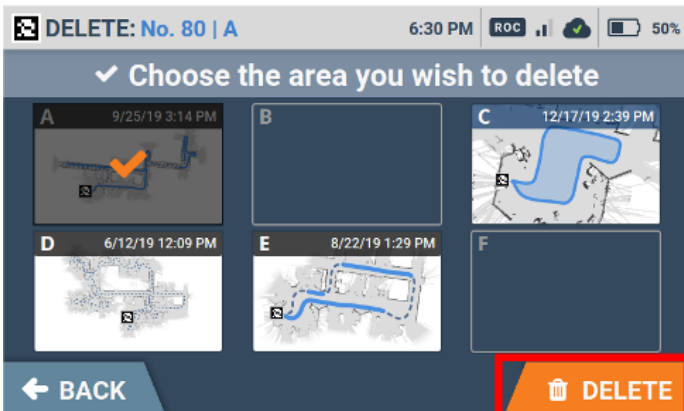

6 Tap "YES-DELETE"

 The selected cleaning route/area is deleted.

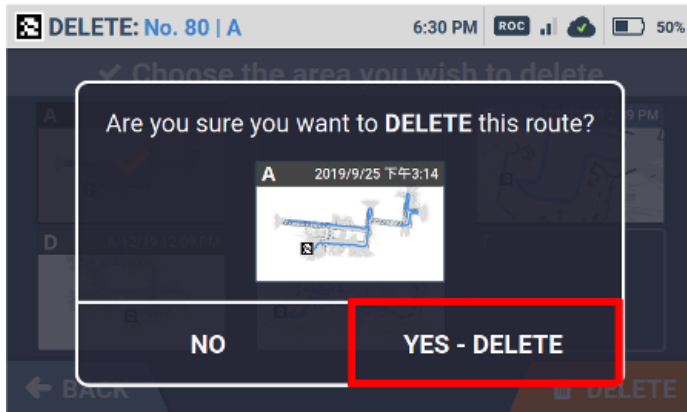

Manual Cleaning

In order to clean areas that cannot be cleaned in autonomous mode, (along a wall, etc), you can use manual mode.

- Before carrying out manual cleaning, be sure to check “Inspection Before Operating the Machine”.

1 Press the main power switch (I/O) to turn it on (I)

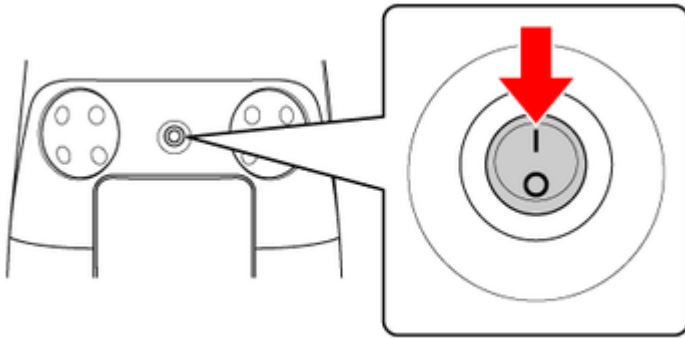

2 Pull the steering handle up as far as it will go, and lower it toward you

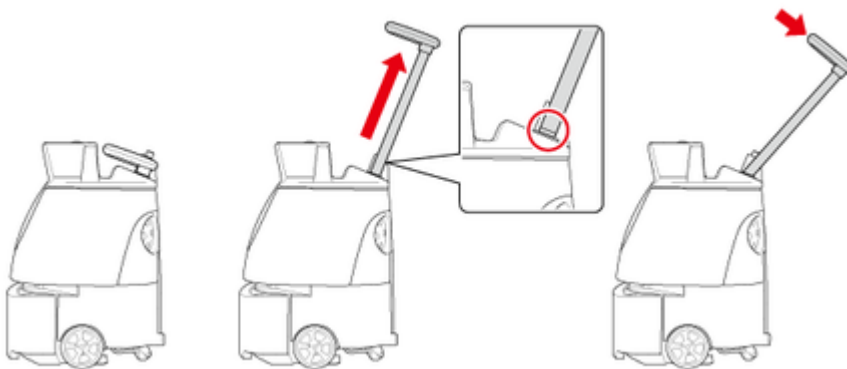

3 Use the vacuum power button and max power mode button to start cleaning (⇒see “Vacuum Power Button”, “Max Power Mode Button”)



- The machine is designed to be moved forward to clean floors; do not move the machine backward.
- During cleaning, do not bring the machine near slopes, platforms, elevators/escalators, or other obstacles.
- Contact the administrator immediately if the machine is damaged or is operating abnormally (such as vacuum failure or a sound of an air leak).

Notification Pager

■ FCC Compliance Statement

Note:

This equipment has been tested and found to comply with the limits for a Class B digital device, pursuant to part 15 of the FCC Rules. These limits are designed to provide reasonable protection against harmful interference in a residential installation. This equipment generates, uses and can radiate radio frequency energy and, if not installed and used in accordance with the instructions, may cause harmful interference to radio communications. However, there is no guarantee that interference will not occur in a particular installation. If this equipment does cause harmful interference to radio or television reception, which can be determined by turning the equipment off and on, the user is encouraged to try to correct the interference by one or more of the following measures:

- Reorient or relocate the receiving antenna.
- Increase the separation between the equipment and receiver.
- Connect the equipment into an outlet on a circuit different from that to which the receiver is connected.
- Consult the dealer or an experienced radio/TV technician for help.

This pager device (**FCC ID: 2AT19-P00000401A01**) is designed to meet the requirements for exposure to radio waves established by the Federal Communications Commission (USA). These requirements set an SAR limit for an occupational/controlled environment of 0.4 W/kg, as averaged over the whole body, and a peak spatial average SAR of 8 W/kg, averaged over any 1 gram of tissue. The highest SAR value reported under this standard during product certification for use when properly worn on the body is 0.06 W/kg. This device was tested for typical body-worn operations with a separation of 10mm from the body. To maintain compliance with FCC radio frequency exposure requirements, use accessories that maintain a 10mm separation distance between the user's body and the back of the pager. The use of belt clips, holsters, and similar accessories that contain metallic components in their assembly should be avoided, as use of such accessories might not comply with FCC exposure requirements.

Notification Pager Functions

The Notification pager will alert the operator via sound and/or vibration when irregularities occur during autonomous cleaning, or when the machine encounters obstacles. When using the notification pager for the first time, please take the pager out of the battery box and charge the pager. (⇒see "Recharging the Notification Pager").

- Notification pager can only be used during autonomous cleaning.

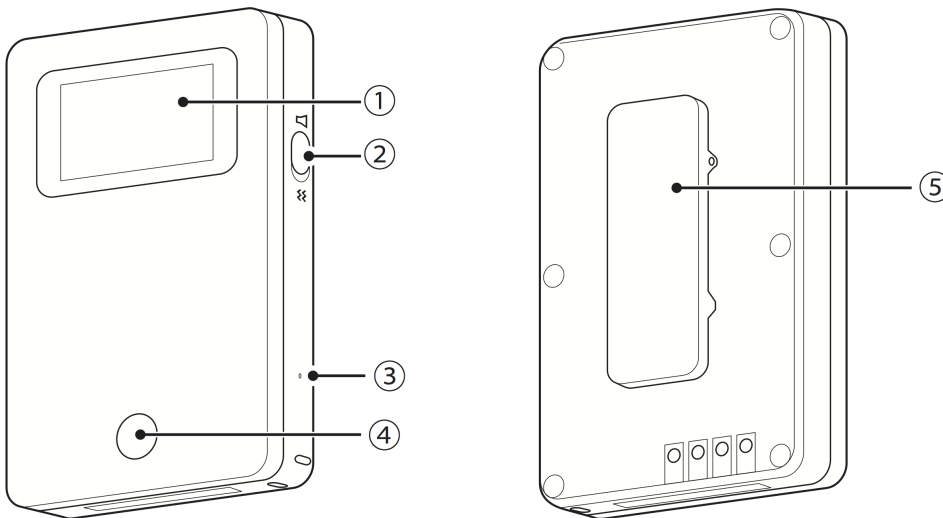

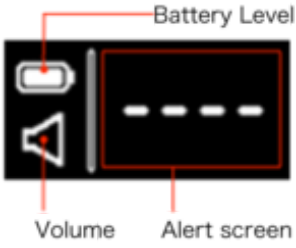
No.		Item
1	Display	<p>The battery level icon and mute icon appear at the left of the display, and alerts appear at the right of the display. (⇒see "Alert display and its notification timing")</p> 
2	Pager mute switch	To set the notification pager only to vibrate for alert notifications, set the pager mute switch on.
3	Power button	Use the given pin to turn the power On for the Notification Pager.
4	Pager main button	To stop the alert and vibration, press the pager main button.
5	Clip	Use the clip when placing the notification pager in your pocket, etc.





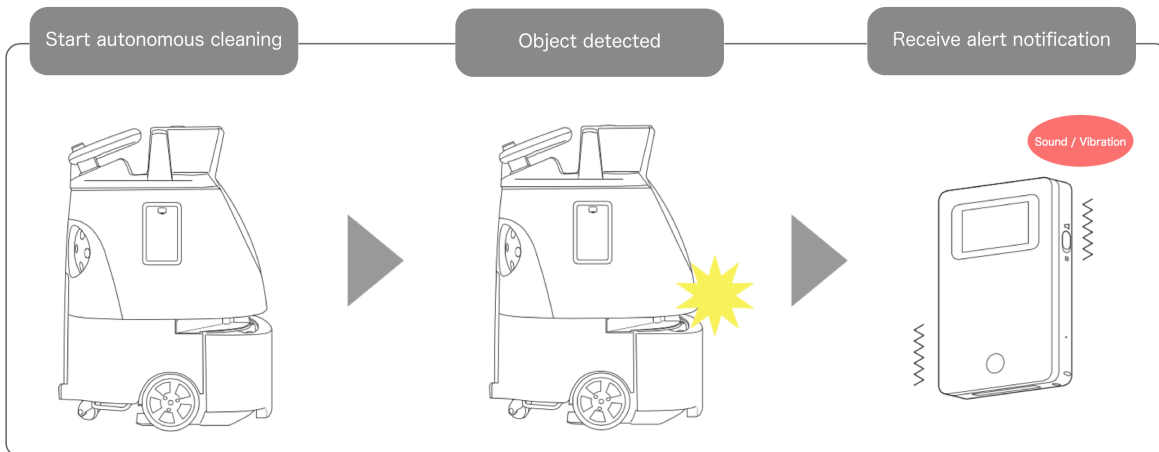

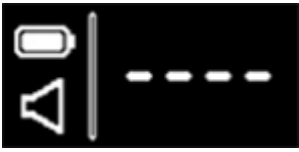

■ Notification Pager Functions & Usage

- When the machine detects danger or detects an obstacle, an alert will be displayed on the notification pager (⇒see "Alert display and its notification timing") and it notifies the operator by emitting an alert and vibrating. It emits an alert and vibrates for 15 seconds then stops for 5 seconds, which it repeats for 10 minutes. After the error with the machine has been resolved, the notification pager sounds for 1 second and its display indicates standby.
- To receive alert notifications, pair the machine and the notification pager. (⇒see "Pairing the Notification Pager") Once the display on the notification pager indicates communication, place it in the pager compartment to complete pairing.



- During autonomous cleaning, always carry the notification pager on you. Alerts cannot be received while the notification pager is in the pager compartment.
- The range in which the notification pager can communicate with the machine is a direct line up to 300 m (2 floors above and below).
 - * Communication range depends on the environment. Walls made of, or containing large amounts of metal may impact communication.
- After using the notification pager, place it in the notification pager charger (⇒see "Recharging the Notification Pager").
- If the notification pager won't be used for a long period of time (approx. 2 months) turn the switch Off (⇒see "Turning the Notification Pager On/Off")

■ Alert display and its notification timing

Appearing on display	Description	Appearing on display	Description
	Standby (within the communication range/paired)		Autonomous cleaning complete
	Machine battery level low		No machine battery remaining
	Dustbag full		Connected for wireless communication
	Connection for wireless communication not possible (outside communication range/not paired)		<p>Error alert</p> <ul style="list-style-type: none"> • When danger has been detected near obstacles or steps • When the emergency stop button has been pressed • When the machine goes off path during the operation

Turning the Notification Pager On/Off

When using the notification pager for the first time, use the supplied pin to turn the power On.

■ Turning the Notification Pager On

1 Insert the supplied pin in the power button on the side of the notification pager

Keep the inserted pin pressed until the notification pager vibrates.

 An icon appears on the display.

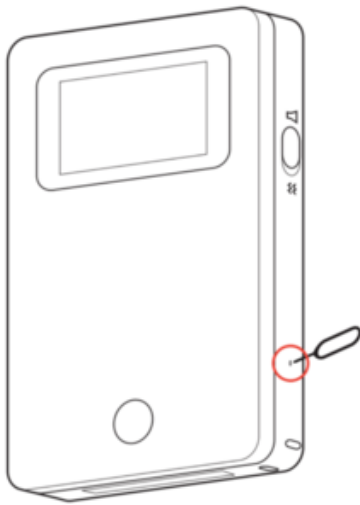

■ Turning the Notification Pager Off

- 1 Insert the supplied pin in the power button on the side of the notification pager
-

 The display turns off.

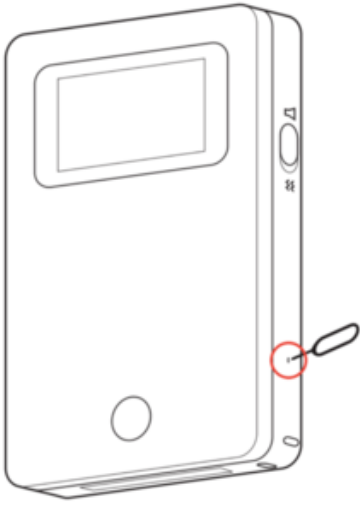

- 2 Press the pager main button, and check that nothing appears on the display
-

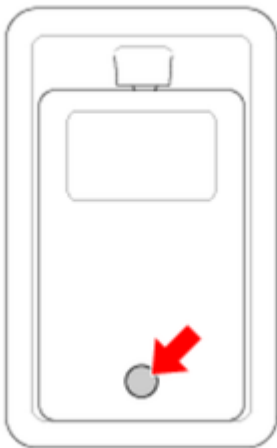

Pairing the Notification Pager

In order to receive the alert on the notification pager, the pager must be paired with the machine itself.

1 Turn On the notification pager and the machine

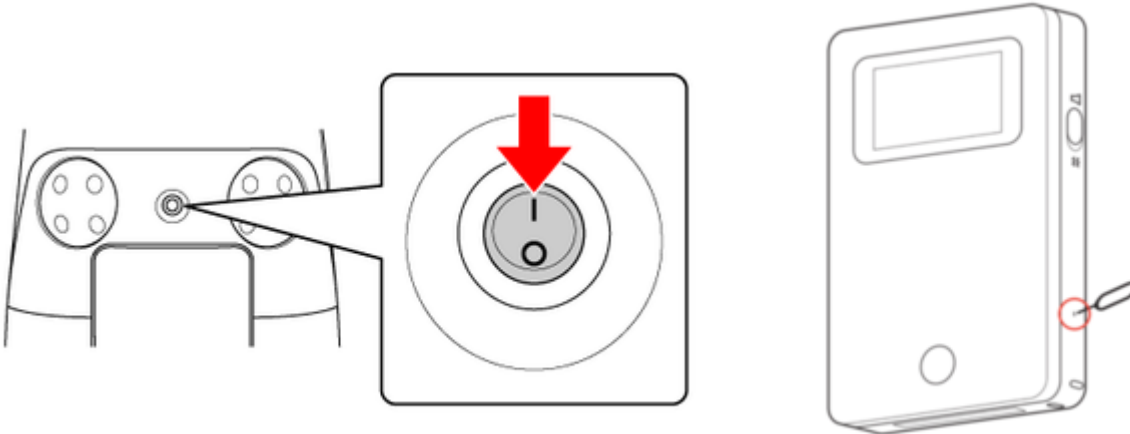

2 Check if the machine is connected to the Robot Operations Center (ROC)

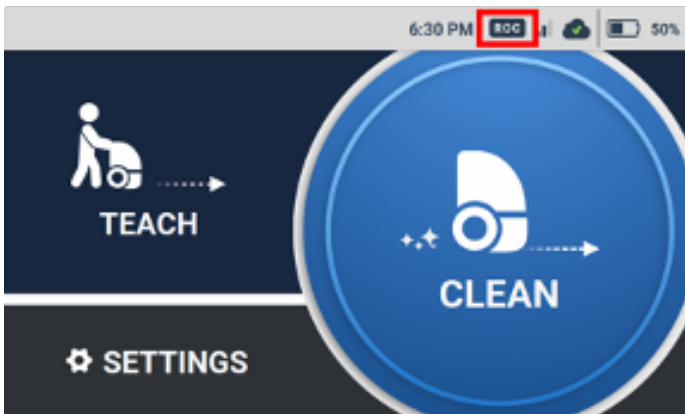

- Please check your mobile phone cellular connection in advance. Robot Operations Center (ROC) will not be connected to LTE in an area where there is no signal.
- The connection status to the ROC will be shown by the ROC indicator on the display (⇒see "Touch Display")

3 Press the button on the notification pager for at least 5 seconds



The message "Wireless connection in process"  will be shown on the pager's display.

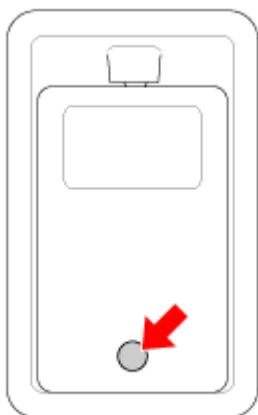

4 Attach the pager on to the pager holder on the side of the machine

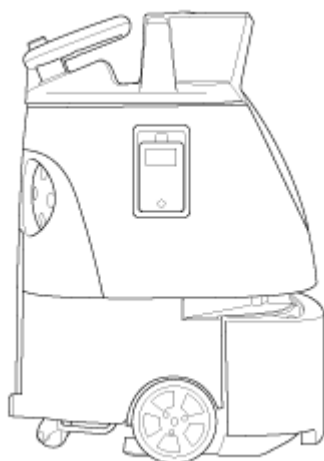

- Carry out autonomous cleaning and check if you will receive the alerts (⇒see "Carrying Out Autonomous Cleaning").

Recharging the Notification Pager

If notification pager battery is running low, charge the pager fully before using it.

1 Insert the Micro USB plug on the cable in the terminal on the back of the notification pager charger

2 Connect the USB plug on the cable in the USB AC adapter, and plug the adapter into an outlet

- The customer must purchase a USB AC adapter themselves.

3 Place the notification pager in its charger

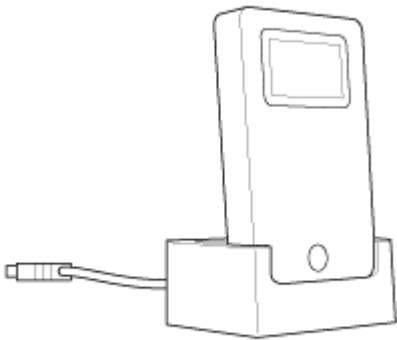

- An AC adapter is not included in the equipment packaging. The customer must use their own AC adapter.
- Press the pager main button, and if the fully charged mark  appears on the display, it has completed charging.
- About 2.5 hours are required to fully recharge.

Machine Battery; Recharging the Machine's Battery

About Battery and Recharging

- The battery operates for about 3 hours when cleaning in normal mode.
- About 4 hours are required for the battery to fully recharge.
- Use only batteries designed for the machine.
- Use only a power cable that came with the machine and is intended for use in the United States or Canada. Do not use any other charger power cable.

Recharging the Battery

Before using the machine, set the main power switch on the machine off and remove the battery. Then place the battery in the charger until fully charged.

When replacing the battery during autonomous cleaning, turn the Secondary Battery Power Button on (⇒see “Secondary Battery Power Button”). After the battery is replaced, turn the Secondary Battery Power Button off.

- As a safety precaution, always use both hands when removing/installing the battery or inserting/removing it from the charger. Doing so with only one hand may allow it to fall, which is very dangerous.

1 Connect the power cable for the charger to the charger, and connect the power plug to an outlet

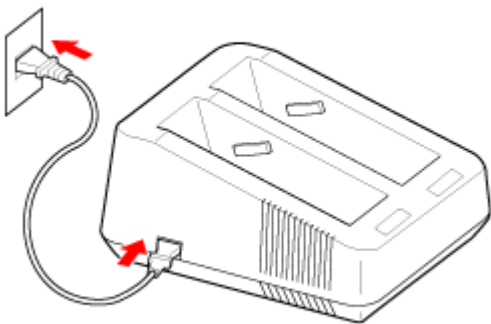

2 Press the main power switch (I/O) to set it off (O)

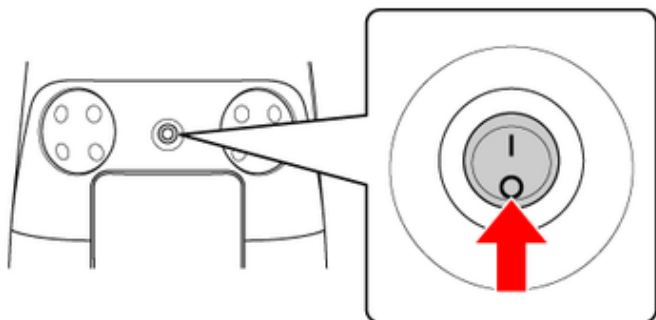

3 Open the battery door by pulling its bottom left toward you

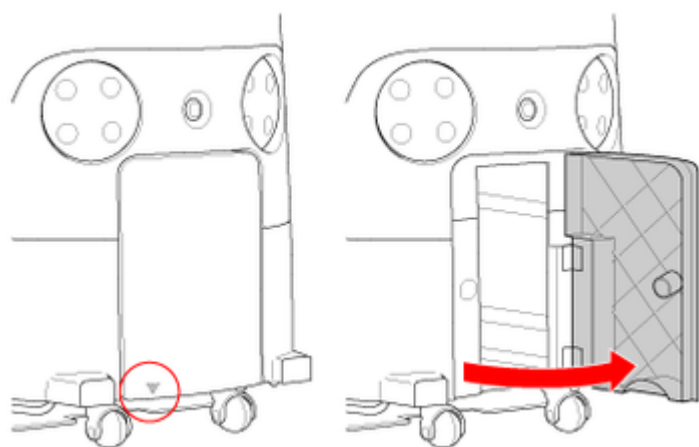

4 Hold the grip on the battery in your right hand, and press the battery lock with your thumb

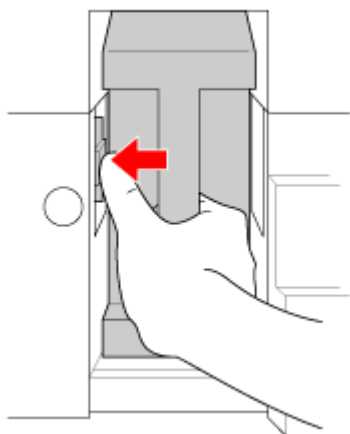

5 Pull the battery out toward you as you release your thumb from the lock

- Be careful not to let your thumb get caught.

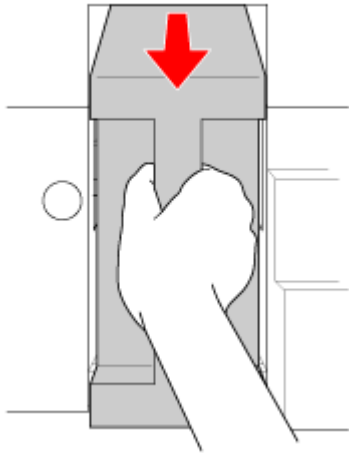

6 Using the handles, pull the battery out

- Be sure to hold the grips with both hands when pulling the battery out.

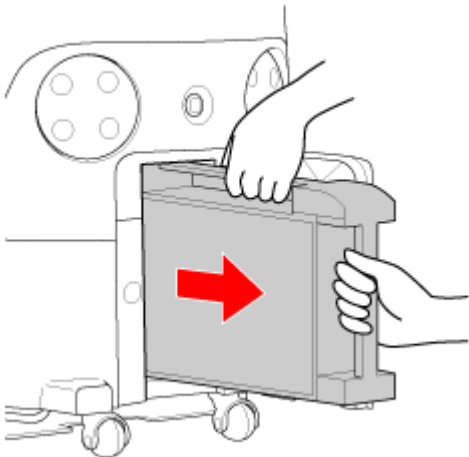

7 Insert the battery straight into the charger all the way

 Recharging starts when the battery is properly inserted in the charger.

- Slide the battery gently into the charging slot. Inserting it from above may damage the charging terminal.
- After inserting the battery, check that the terminals on the battery and the charger are connected firmly.

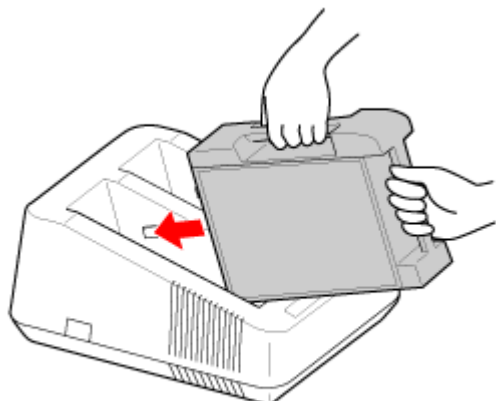

8 After recharging the battery, check that the charging status light is flashing in green

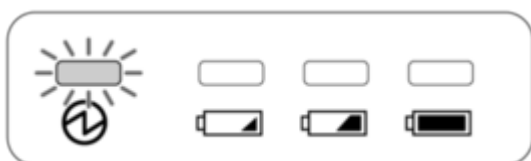

9 Once the battery is recharged, pull it straight out of the charger and then lift it up

- Slide the battery out of the charging slot.
- Be sure to hold the handles with both hands when pulling the battery out.

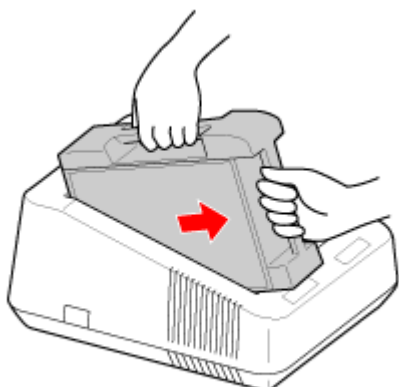

10 Insert the battery all the way into the battery compartment, and close the battery door

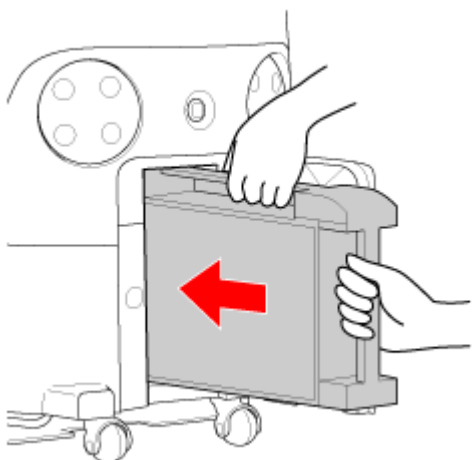

- Insert the battery in the battery compartment by its terminal first.
- Once the battery is properly inserted, the lock in the battery compartment will pop into place, making a “click”.

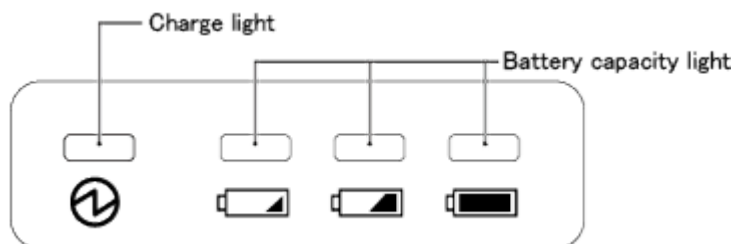

■ Battery Charger Status Indicator

Charging status is indicated by the light on the charger.

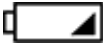

Status		Charge light	Battery capacity light
Recharging	Battery capacity: less than 5% 	Lit orange	One lit green
	Battery capacity: 5 to 95% 	Lit orange	Two lit green
	Battery capacity: more than 95% 	Lit orange	Three lit green
Recharged		Flashing green	Not lit
Abnormal		Flashing red/lit red	Not lit

Maintenance and Safety

About Maintenance and Safety

After completing cleaning, carry out maintenance on the following parts every day. Before carrying out maintenance, make sure to turn off the main power switch on the machine (⇒see “Main Power Switch”).

- Brush (⇒see “Brush”)
- HEPA filter (⇒see “HEPA Filters”)
- Hopper tray (⇒see “Hopper Tray”)

- Machine repair should only be carried out by technical staff approved by SoftBank Robotics.
- Turn off the main power beforehand to disinfect the machine with alcohol. Use the amount of alcohol to some degree that a soft cloth is slightly wet. Avoid disinfecting Rubber pad, the base of the steering handle (the rubber part), and the wheels.

Brush

Remove the brush, and remove any dirt or hair caught in it as necessary. If the brush is damaged, replace with a new brush following the steps below.

- When cleaning the brush, do not pull the brush forcefully. Doing so may damage the brush.
- If the bottom of the machine is dirty, wipe with a dry cloth.

Removing the brush

- 1 Stow the steering handle (⇒see 'Steering handle')**

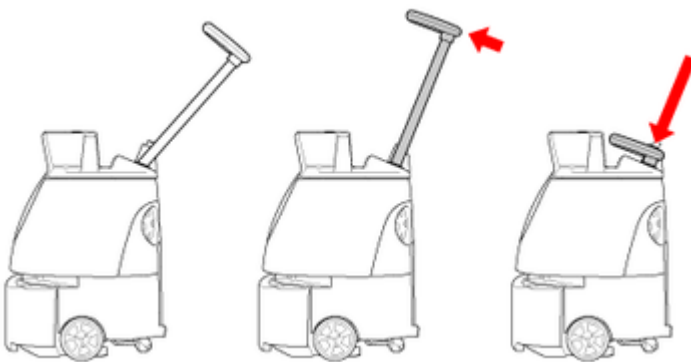

2 Hold the lift handle with one hand, and hold the steering handle down with another hand.

- Please operate with two people.

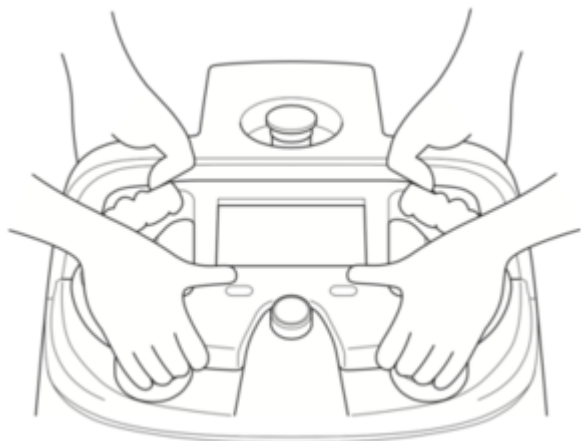

3 Gently lay the machine down so that the dustbin faces upward.

 Rubber pad will support and stabilize the machine.

- Please ensure that the steering handle does not stick out of the machine.
- Try to avoid letting the machine fall or turn over on its side.
- A concrete or other hard surface will scratch the machine; place the machine on carpeting or other soft and flat surface.

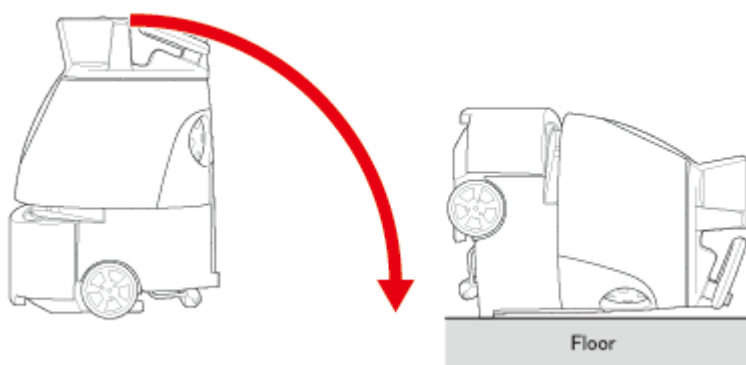

4 Press the brush to the right, and pull the left end out toward you to remove

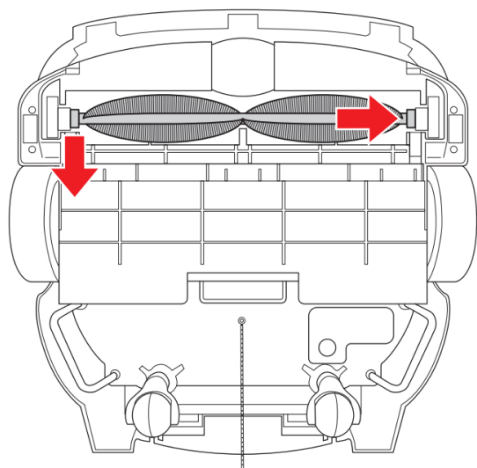

5 Remove the right end of the brush

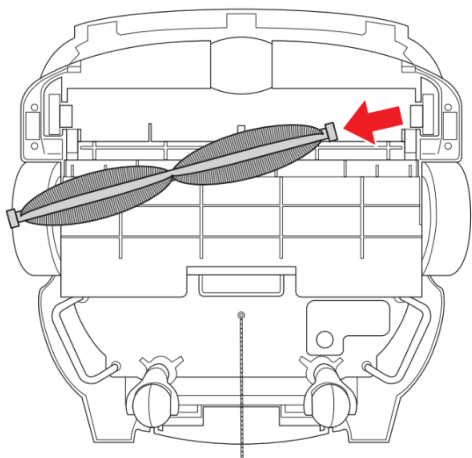

■ Mounting a new brush

1 Check the marks on the left and right ends of the new brush

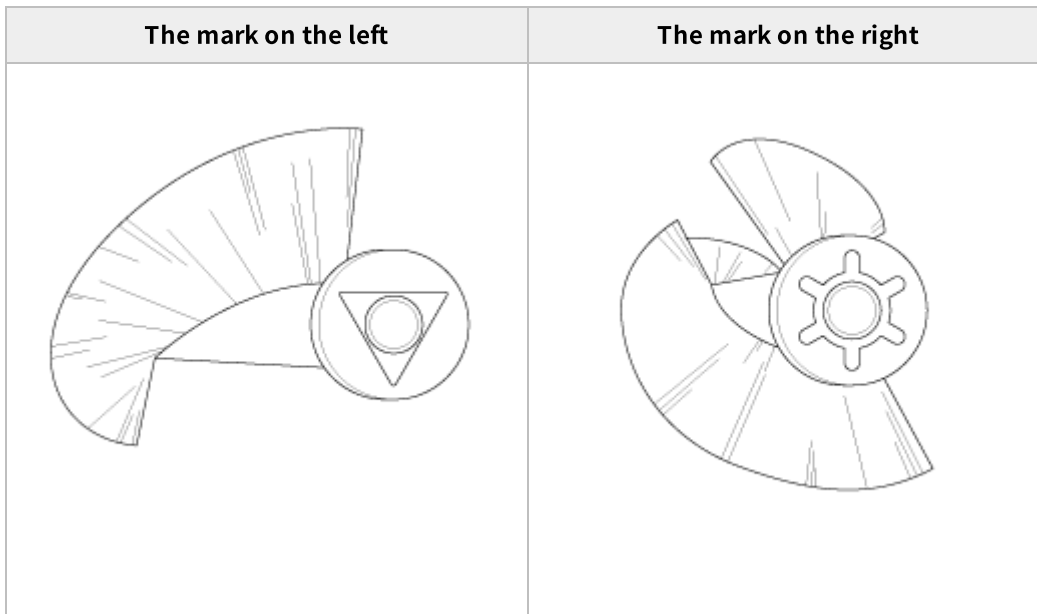

- When the machine is laid down, with the front side facing up, you will see the sockets of the brush compartment. These sockets correspond to the right and left sockets of the brush.

2 Insert the right end of the brush into the corresponding socket of the brush compartment.

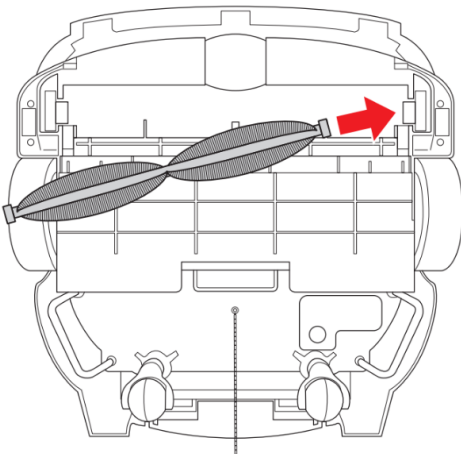

3 Push the brush in to the right, and attach the left end of the brush to the socket while aligning the same marks.

- Turn the brush, and check that both ends of the brush are securely attached in the sockets.

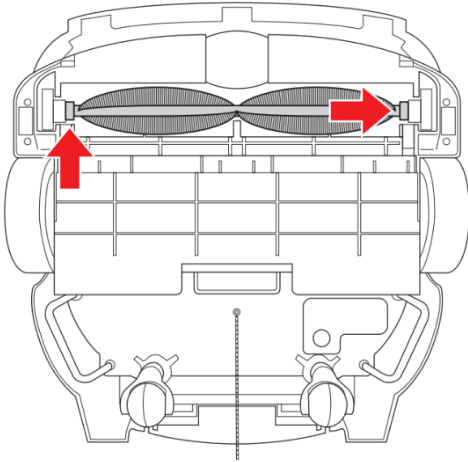

4 Hold the lift handle with one hand, and hold the steering handle down with another hand.

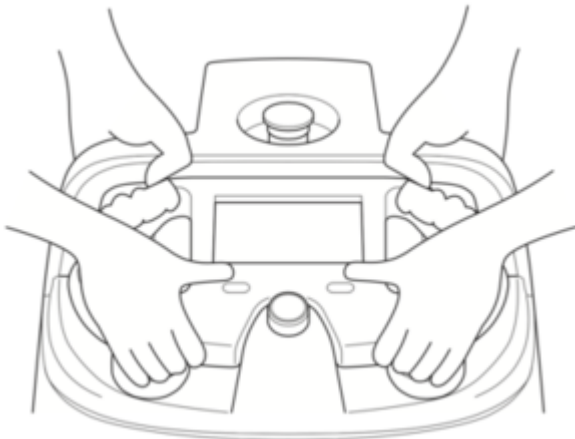

5 Holding the lift handles by both hands, gently raise the machine

- Please ensure that the steering handle does not stick out of the machine.

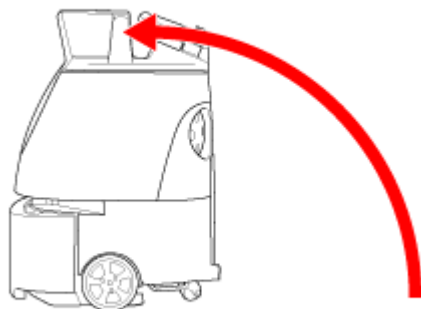

HEPA Filters

Check that dirt has not accumulated in the HEPA filters and that they are not damaged. If dirt has collected or they are damaged, replace them with new filters following the steps below.

- Do not wash the HEPA filters with water.
- When disinfecting around the HEPA filters with alcohol, avoid the rubber parts.

1 Place your fingers in the holes of the filter cover and turn to the left to remove

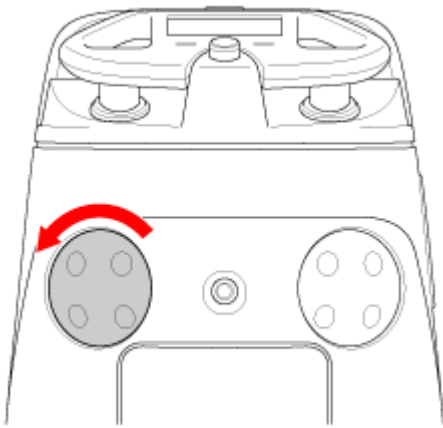

2 Hold the HEPA filter by the tab in the middle and remove

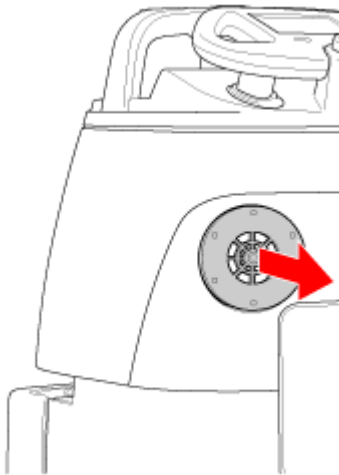

3 Install the new HEPA filter, replace the filter cover, and turn to the right to close

- Replace the other HEPA filter also as required.

Dustbag

Replace with a new dustbag when it gets full.

■ Remove the dustbag

- 1** Hold by the dustbin access handle and pull down
-

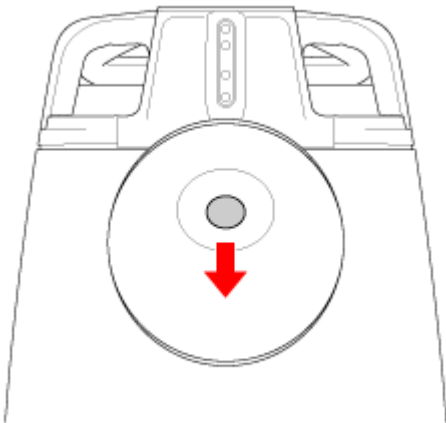

- 2** Pull the cover towards you to remove
-

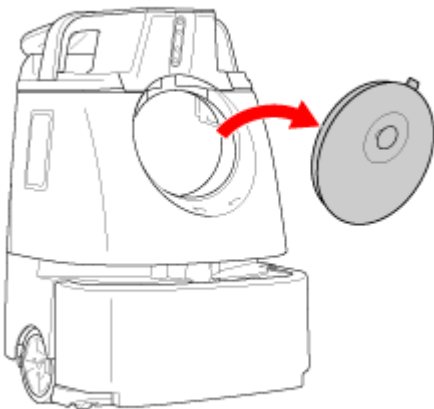

3 Pull out the attachment sheet for the dustbag inside the dustbin

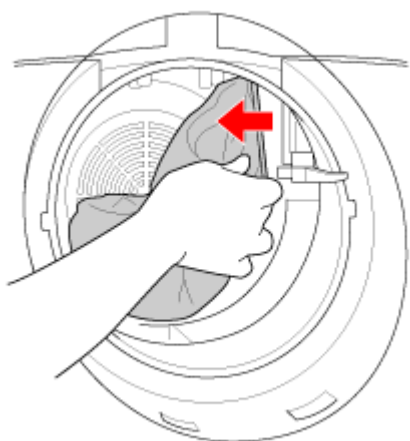

4 Remove the used dustbag from the dustbin

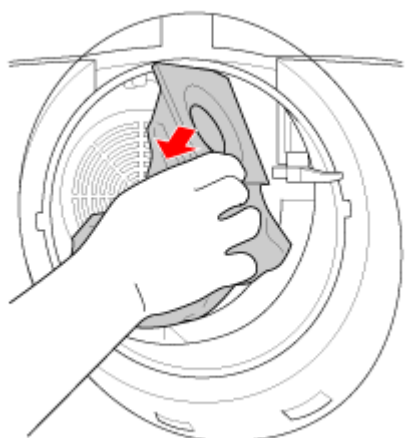

■ Attach the new dustbag

1 Spread the new dustbag out and inflate

- Please be careful not to rip the dustbag.

2 With a new dustbag, hook the left side of the attachment sheet to the catch on the left side of the suction port

- Follow the illustration on the dustbag and make sure that the side of the illustration faces upwards.

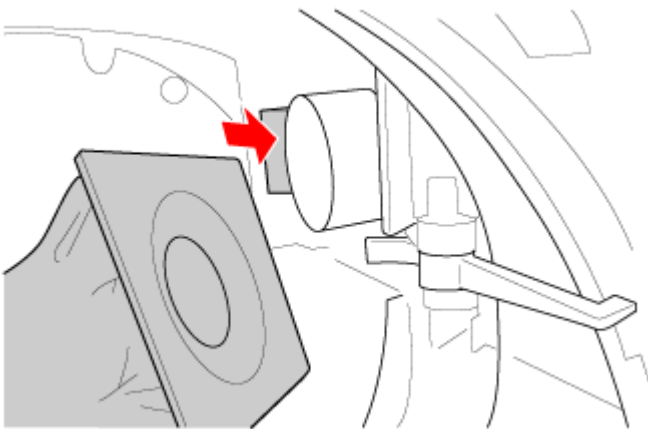

- The suction duct inside the dustbin appears as below when viewed from the front. The latch is visible on the left.

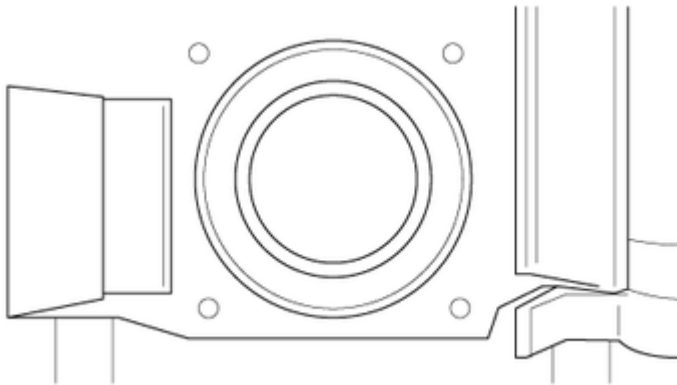

3 Align the opening in the attachment sheet with the suction duct, and push the right of the attachment sheet in firmly

- Be careful not to pinch your fingers.

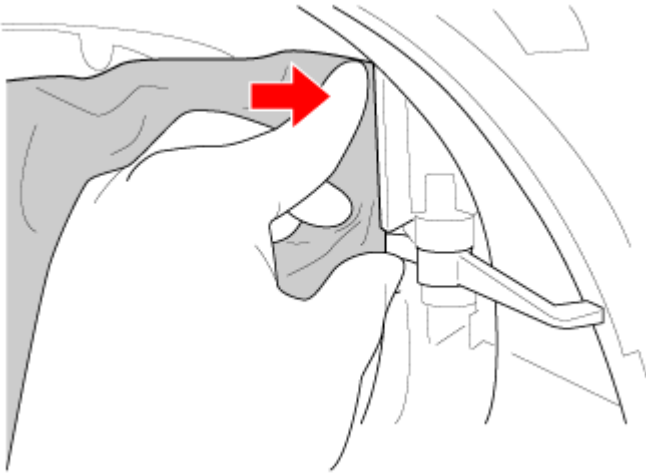

4 Check that the dustbin pin is afloat

- If the dustbag is attached properly, the stopper in the dustbin is raised away as shown below. If the dustbag is not attached properly, the stopper will prevent the dustbin cover from being closed. Closing the cover forcefully may cause damage.

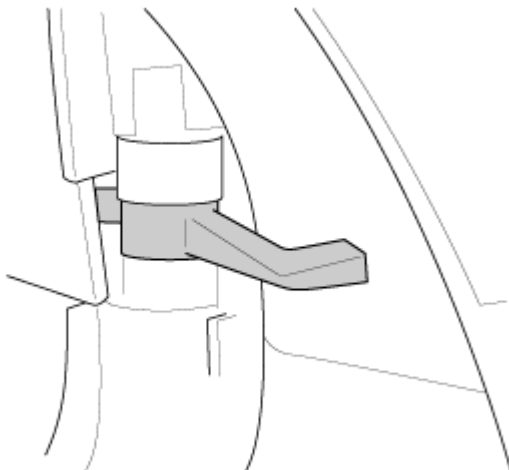

5 Insert the catches at the bottom of the cover in the bottom of the dustbin (1), and close the cover while holding the dustbin access handle down (2)

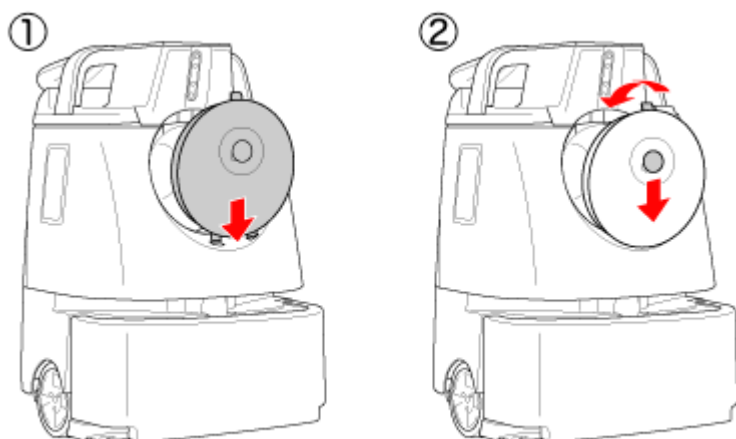

Hopper Tray

Empty the hopper tray after every cleaning. Remove and replace the hopper tray following the steps below.

- The hopper tray is shaped as below, and is located on the bottom of the machine (⇒see “Names of Parts”).

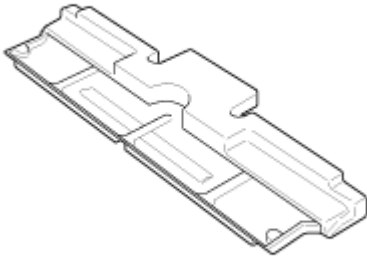

- Do not remove the hopper tray while the machine is laying on its side. Doing so will allow dirt in the hopper tray to scatter.
- Be careful not to injure yourself when removing the hopper tray.

1 Pull the hopper tray out by its handle

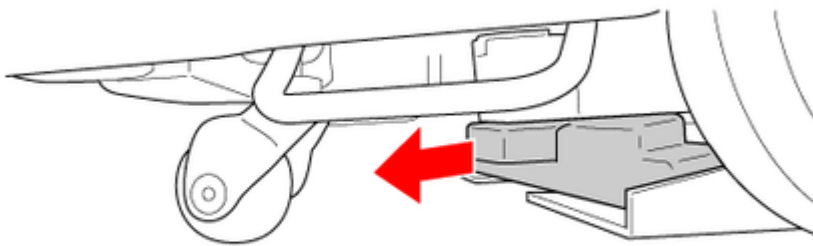

2 Pull the hopper tray out on the left (direction of arrow)

- The hopper tray cannot be pulled out on the right.
- To ensure adequate space for pulling the hopper tray out, orient the rear caster backward as shown.

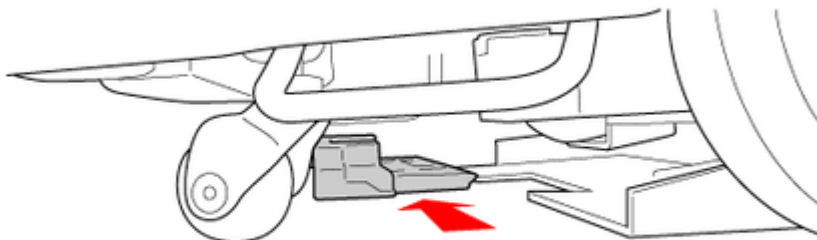

3 Discard any dirt in the hopper tray

- Wash the hopper tray with water if dirty. After washing, wipe away any water with a dry cloth and allow to dry.

4 Slide the hopper tray into the bottom of the machine from the left

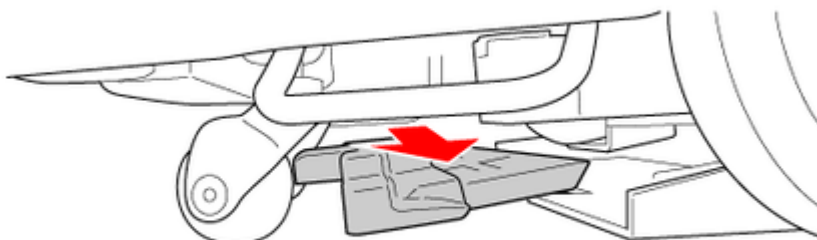

5 Press the hopper tray all the way in

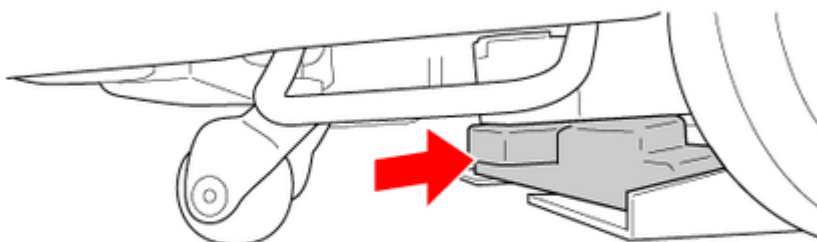

Battery Charger

Before recharging the battery, check that no dust or dirt is present in the air vents on the charger.

1 Remove any dust or dirt from the air vents

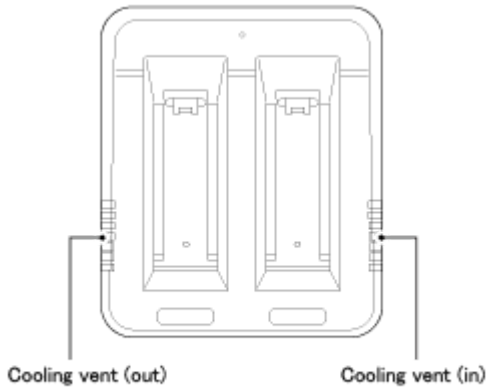

- Check visually for anything abnormal (discoloration, corrosion) and for any abnormal sound, etc. from inside the charger

Sensors

If dust or dirt is on the sensor, remove by using a micro-fiber cloth.

■ 2D/3D Camera (sensor), LIDAR sensor

1 Wipe the 2D/3D camera (sensor) and LIDAR sensor with the micro-fiber cloth

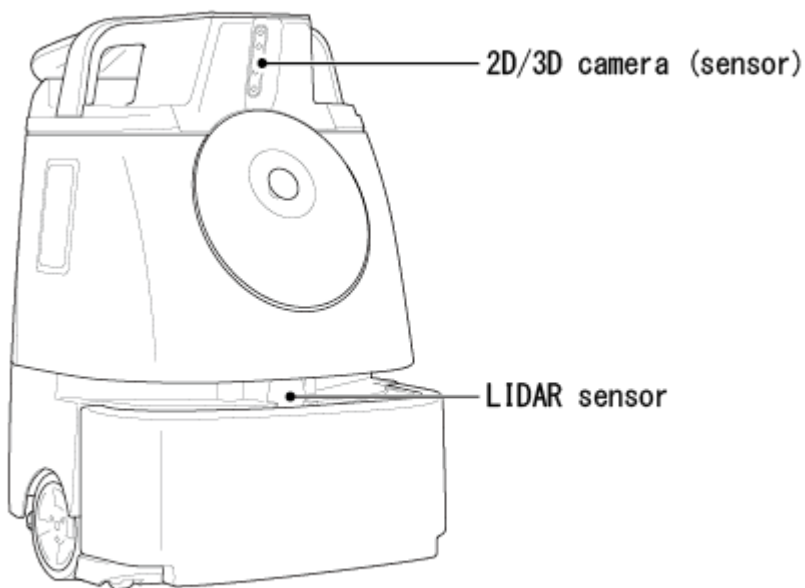

2 Check that nothing is caught in the gaps around the bumper, and that the machine moves back several centimeters when the bumper is pushed slightly

■ Cliff sensor

1 Stow the steering handle (⇒see "Steering Handle")

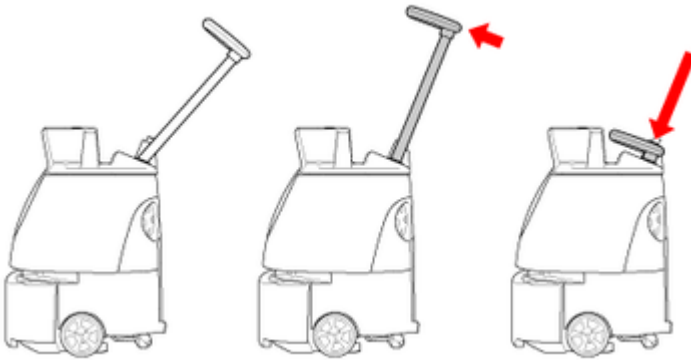

2 Hold the lift handle with one hand, and hold the steering handle down with another hand.

- Please operate with two people.

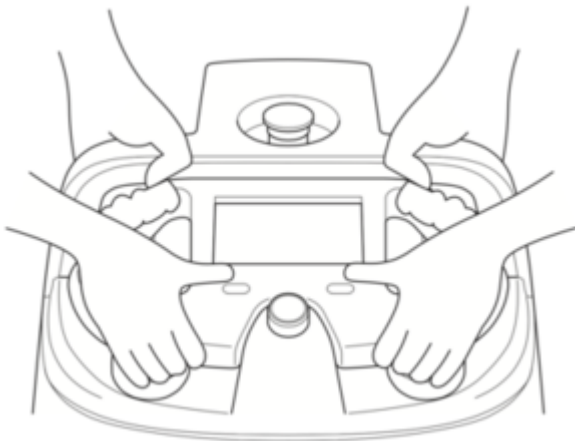

3 Holding the lift handles with both of your hands, gently lay the machine on its side so that the side with the dustbin is up



When the machine is laying on its side, it is supported by the rubber pad.

- Please ensure that the steering handle does not stick out of the machine.

- Try to avoid letting the machine fall or turn over on its side.
- A concrete or other hard surface will scratch the machine; place the machine on carpeting or other soft and flat surface.

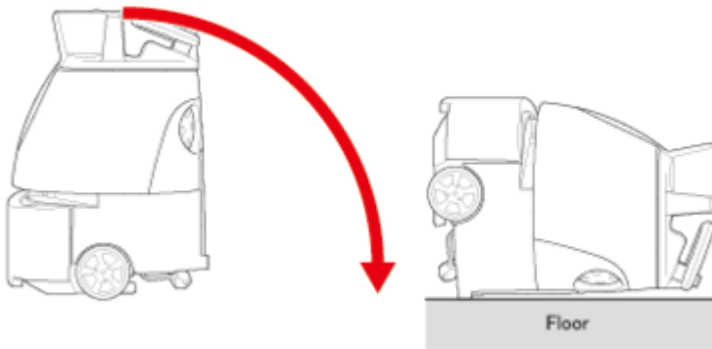

4 Wipe the cliff sensors with the micro-fiber cloth

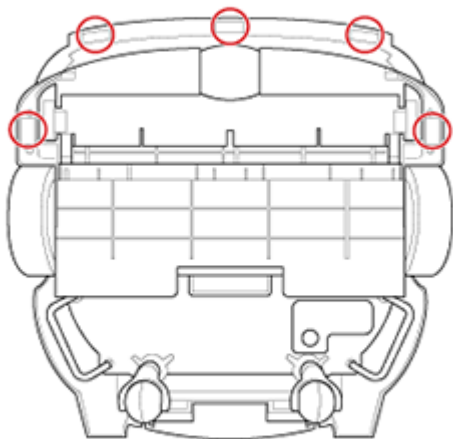

Storing the Machine

Once cleaning is complete, move the machine manually to its predetermined place of storage.

- When not using the machine, store it with its power turned off.
- If not using the machine for a long time, turn off the Secondary Battery Power Button (⇒see “Secondary Battery Power Button”).
- Store the machine where it will not be a hindrance to fire doors, stairs, or firefighting equipment.
- Always store in a dry indoor location free of humidity.
- After use, always turn the machine off and recharge its battery.

Packaging the Machine

If not using the machine for a long time, follow the steps below to pack the machine. As a safety precaution, always work with at least two people.

- Before packing the machine, be sure to remove the battery (⇒see “Machine Battery; Recharging the Machine's Battery”).
- Pack the notification pager and brush in the special packaging box.

1 Insert the cushioning material (between the bumper and the machine).

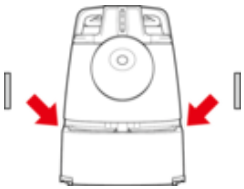

2 Wrap the machine with a plastic bag.

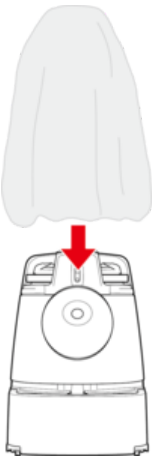

3 Hold the lift grips and place the machine into the inner box.

- Align the direction of the cushioning material and the inner box



4 Insert the cushioning material.

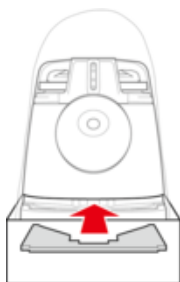

5 Cover the inner box with the outer box.

- Cover the outer box as the same direction as the cushioning material inside the inner box.

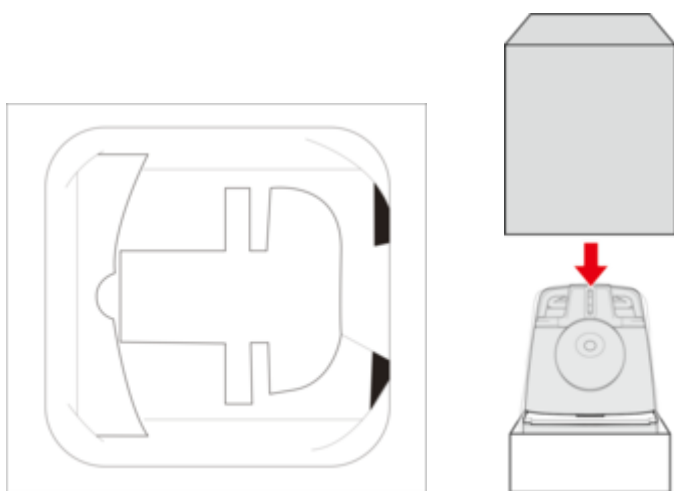

6 Attach the locking tab to the outer box

- There are 4 locking tabs on the outer box.

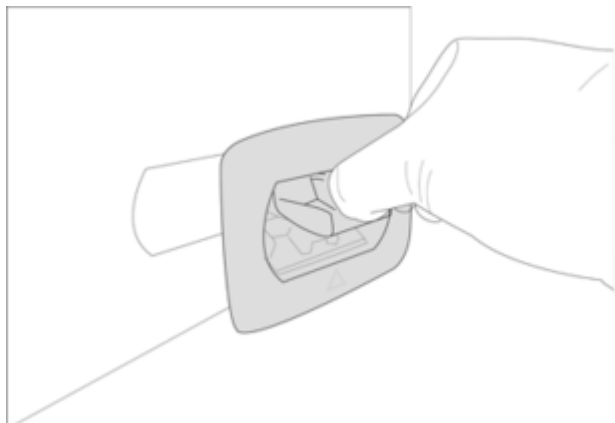

7 Press the locking tab lock until you hear a "click".

- Locking tab will lock.

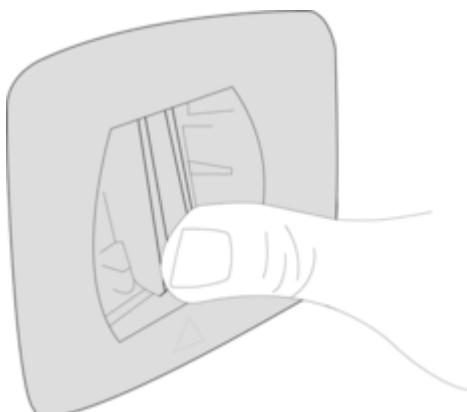

8 Make sure the locking tab will not come off from the outer box.

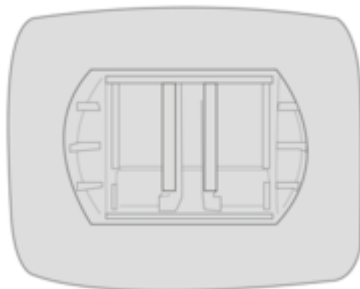

Troubleshooting

Stopping/Pausing the Machine

- 1 On the back of the machine, press the autonomous clean start/stop button

 The machine stops.

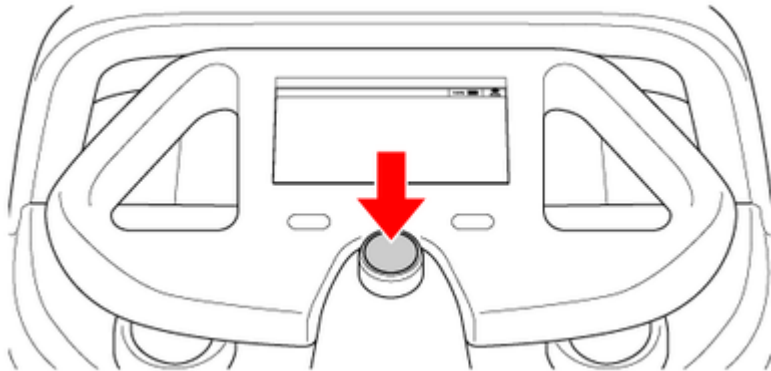

- To restart machine operation, press the autonomous clean start/stop button again.
- To stop auto cleaning, tap “CANCEL ROUTE” on the touch display.

Emergency Stop

If an emergency occurs, press the emergency stop button and immediately stop the machine.

- Only use the emergency stop button in an emergency.
- To pause the machine during autonomous cleaning, use the autonomous clean start/stop button (⇒see “Autonomous Clean Start/Stop Button”).

■ Stopping the Machine in an Emergency

1 Press the emergency stop button



The machine will stop and an alert will be notified on the notification pager(⇒See "Notification pager").

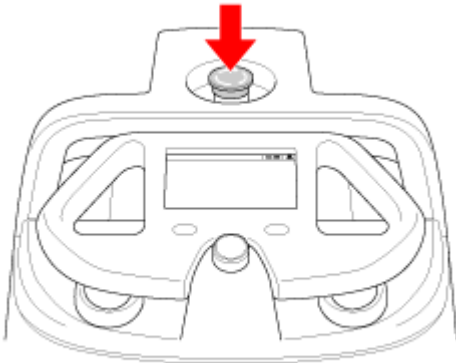

- The machine will stop, but the power is not turned off.

■ Releasing the Machine from Emergency Stop

- Check the safety of the machine and surrounding area before releasing the machine from emergency stop.

1 Turn the emergency stop button to the right

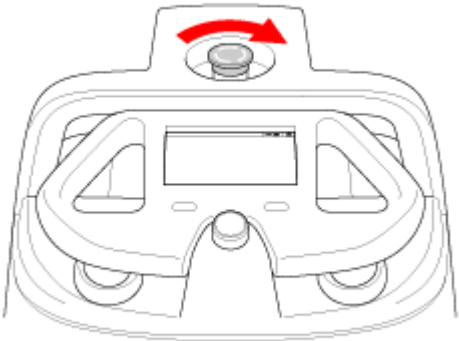

- Check that the button springs up.

2 Press the autonomous clean start/stop button

 Autonomous cleaning resumes.

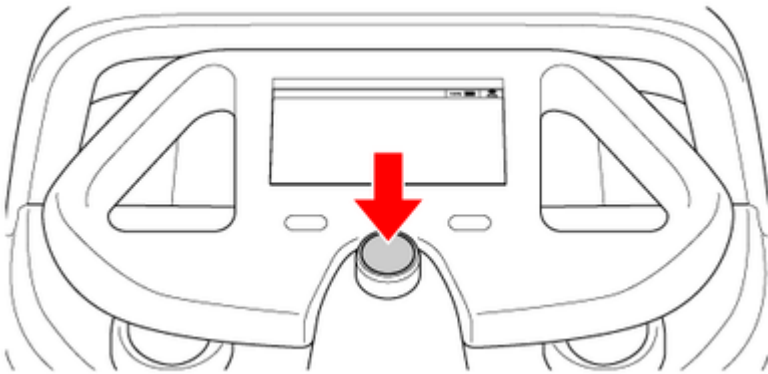

- To stop autonomous cleaning, tap “CANCEL ROUTE” on the touch display.

Checking Machine Alerts

During an autonomous operation, if the machine encounters an obstacle, senses danger or if the battery is low, there will be a notification alert on the touch display. (⇒see “Touch Display”).

If you see an alert, please follow the instructions on the touch display.

1 Tap the alert appearing at the upper left of the touch display

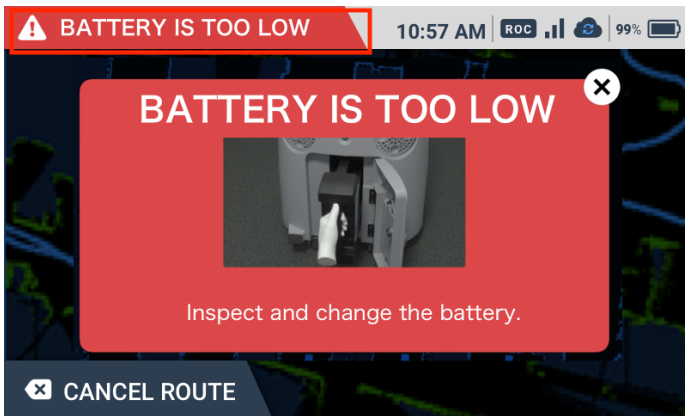

2 Follow the instructions on the screen

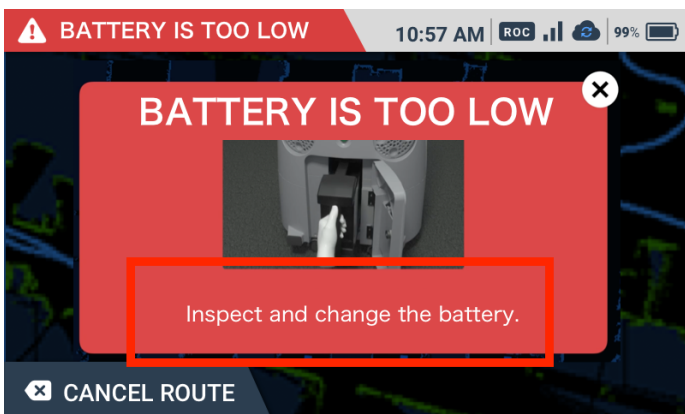

- If the machine stops moving and notifies the operator with an alert at the same location several times, check the problematic cleaning area, Home Location Code, cleaning route, and contact customer support.
- If a problem cannot be remedied, contact customer support. The RIN (the machine’s serial number) is required when inquiring with customer support. The RIN appears on a sticker located on the inside of the battery door on the machine.

Machine Specifications

Machine size (length × width × height)	474mm × 455mm × 653mm (18.6 in × 17.9 in × 25.7 in)
Machine weight	Approx. 30 kg (66 lbs)
Machine weight (battery installed)	35 kg (77 lbs)
Cleaning width	360 mm (14 in)
Maximum inclination	0% (during auto cleaning)
Battery	Lithium-ion battery
Battery output voltage	25.2 V
Battery rated capacity	23.7 Ah
Operating temperature range (charger/battery)	0°C to 45°C
Battery size (length × width × height)	290 mm × 215 mm × 79 mm (11 in × 8.5 in × 3.1 in)
Battery weight	Approx. 5 kg (11 lbs)
Operating time	Approx. 3 hours (normal mode) / approx. 1.5 hours (max power mode)
Time to fully recharge	4 hours
Charger size (length × height × width)	410 mm × 350 mm × 185 mm (16 in × 13.8 in × 7.3 in)
Charger weight (incl. power cable)	4.2 kg (9.3 lbs)
Charger power source	100 to 240 V AC
Charger rated output voltage	29.4 V DC/8 A × 2

Glossary

	Terminology	Description
A	Accessory box	The box includes notification pager, notification pager charger, pin and micro-fiber cloth. Upon arrival, accessory box will be stored inside the battery box.
	Autonomous clean start/stop button	Use to start autonomous cleaning mode or to pause/resume autonomous cleaning. The autonomous clean start/stop button (⇒see “Autonomous Clean Start/Stop Button”) can only be used in autonomous cleaning mode.
	Autonomous cleaning	The operator teaches a cleaning route on the machine beforehand(⇒see “Teaching a Cleaning Route Manually” or “Teaching a Cleaning Route Automatically”) so that the machine can clean by itself without the operator cleaning with it manually. When using autonomous cleaning, stow the steering handle in the main unit beforehand as a safety precaution. (⇒see “Autonomous Cleaning (Robot)”)
B	Battery	Battery in the machine. Use the special charger for recharging the battery. (⇒see “Battery and Recharging”)
	Battery charger	Charger for recharging the machine’s battery. (⇒see “Recharging the Battery”)
	Battery Compartment	Box where the machine’s battery is inserted.
	BrainOS	Innovative artificial intelligence (AI) technology developed by Brain Corp. for allowing a unit to clean on its own.
	Brush	Rotating brush that collects dirt and dust into the hopper tray, and also aids efficient vacuuming. (⇒see “Brush”)
	Bumper	Shock absorber for impact or vibration if the machine contacts obstacles, etc.
D	Display (notification pager)	The screen is for checking the notification pager's battery level, Robot Operations Center (ROC) connection status, alerts, etc. (⇒see "Notification Pager Functions")
	Dustbag	Dustbag for collecting vacuumed dirt and dust. (⇒see “Dustbag”)
	Dustbin	Box in which the dustbag (⇒see “Dustbag”) is attached.
	Dustbin access handle	Knob on the dustbin cover for opening and closing the dustbin.
	Dustbin cover	Cover on the dustbin. Before closing the dustbin cover, check that the dustbag (⇒see “Dustbag”) inside the dustbin is attached properly.
E	Emergency stop button	Button used in an emergency. Pressing the emergency stop button immediately brakes the machine and all functioning stops. (⇒see “Emergency Stop”) To resume autonomous cleaning after an emergency stop, turn the emergency stop button to the right to release the emergency stop and press the autonomous clean start/stop button. (⇒see “Autonomous Clean Start/Stop Button”)
G	Group Function	It is a function that multiple robots can share cleaning routes. (See “Group Function and Cleaning Routes”) Need to create a group in advance through the Whiz Connect Portal, and assign robots to the group.
	Grounding chain	Chain for channeling the machine’s electrical charge (static electricity) to the ground. Before using the machine, check that the grounding chain is in contact with the floor.

	Terminology	Description
H	HEPA filters	High-performance exhaust filters located at the exhaust of the machine for removing dirt and particles. (⇒see “HEPA Filters”)
	HEPA filter covers	Removable covers on the machine’s exhaust. (⇒see “HEPA Filters”)
	Home Location Code	Code used for having the machine learn where cleaning start/end points are in autonomous cleaning mode. One code can be used for the machine to learn six routes. (⇒see “Home Location Codes and Cleaning Routes”)
	Hopper tray	Tray for holding dirt collected by the brush. Discard any dirt in the tray after every cleaning. (⇒see “Hopper Tray”)
L	LED lights	LED lights for indicating machine status, safety, and errors. LED lights are located at positions from the front of the machine to its back, and light in different colors and patterns. (⇒see “LED Lights”)
	Lift handles	Used when lifting the machine from the floor. For your safety, work with two people when lifting the machine.
M	Main power switch	Switch for turning on/off the machine. Press “I” to turn the machine on, and “O” to turn the machine off. (⇒see “Main Power Switch”)
	Manual cleaning	Use the handle for making the machine travel through and clean a cleaning area manually. (⇒see “Manual Cleaning”)
	Max power mode	Mode with more vacuum power than normal mode. Cleaning in max power mode is recommended for cleaning especially dirty locations. (⇒see “Max Power Mode Button”)
	Max power mode button	Button for switching from normal mode to max power mode. (⇒see “Max Power Mode Button”)
	Micro-fiber cloth	Cloth used during maintenance of the 2D/3D camera, LIDAR sensor, and cliff sensor.
N	Normal mode	The usual mode for cleaning. (⇒see “Max Power Mode Button”)
	Notification pager charger	Used for recharging the notification pager. Use a Micro USB cable to recharge the notification pager.(⇒see “Recharging the Notification Pager”)
	Notification pager	Receives alert messages when the machine encounters obstacles or if the emergency stop button is pressed during an autonomous operation. When an alert is received, it notifies the operator with sound and vibrations. (⇒see “Notification Pager”). To recharge the notification pager, use the special charger.
	Notification	Low battery level and errors are reported as notifications. Notifications appear at the upper left of the machine’s touch display. (⇒see “Touch Display”)
O	Operator	The person who operates and manages the machine.
P	Pager compartment	Used for attaching the notification pager on the machine.
	Pager main button	Button for turning the notification pager (⇒see “Notification Pager”) on/off.
	Pager mute switch	Switches the alert on/off that sounds when the notification pager receives an alert message. (⇒see “Notification Pager”)

	Terminology	Description
R	RIN	The machine's serial number. The RIN is indicated on a sticker located on the inside of the battery door on the machine.
	Robot Operations Center	The Robot Operations Center is Brain Corp.'s cloud-based robotics center. Via LTE connection, it provides remote monitoring and managed usage of the machine, and automatically sends reports on daily use and cleaning results, software updates, and messages indicating the occurrence of any abnormalities to the operator.
	ROC indicator	When the machine is connected to the Robot Operations Center (ROC), the ROC indicator will display on the touch display. (⇒see "Touch Display")
S	Secondary battery power button	This button is used to replace the battery while the machine is on during autonomous cleaning. When using this machine or when not using it for a long time (1 week or more), turn off the secondary battery power button and turn it on only when replacing the battery (⇒see "Secondary Battery Power Button").
	Steering handle	Handle for moving the machine while it is standing on its wheels, using for manual cleaning, and when teaching a cleaning route. When carrying out autonomous cleaning, stow the steering handle in the main unit beforehand as a safety precaution. (⇒see "Steering Handle")
T	Teach route	Use Home Location Codes to teach cleaning routes in autonomous cleaning mode. (⇒see "Teaching a New Cleaning Route") A cleaning route can be taught either automatically (see "Teaching a Cleaning Route Automatically") or manually (see "Teaching a Cleaning Route Manually")
	Teaching route	Having the machine learn a cleaning route beforehand to use during autonomous cleaning. (⇒see "Teaching a Cleaning Route Manually" or "Teaching a Cleaning Route Automatically")
	Touch display	Screen for checking the machine's battery level and operating time, connection to the Robot Operations Center, error messages, etc. Cleaning routes are also taught and selected by tapping the touch display. (⇒see "Touch Display")
V	Vacuum power button	Button for starting/ending vacuuming. (⇒see "Vacuum Power Button")
W	Whiz Connect app	App for checking current robot operation and alerts.
	Whiz Connect Portal	Portal site allowing management of current robot operation and alerts as well as downloading of operation reports.

SoftBank Robotics Corp.